

節亮康復產品有限公司產品手冊

Health Product Catalog

Health Care Products

UVC Sterilizer

Rehab Products

Your Smart Health Care Solution Partners

2023



Ziglite Smart Health Care Products Co., Ltd.
節亮康護產品有限公司

Hong Kong Office Address

Room B3, 18/F Bonsun Industrial Building, 364-366 Sha Tsui Road, Tsuen Wan,
Hong Kong

Office Hour : Mon - Fri : 9:30 - 5:30pm

Email : info@ziglite.com

Office : +852 3974 5593

Fax: +852 3544 0462

Whatsapp : +852 6756 7703

Wechat ID : Gg971213, helen-3110

Ziglite Smart Health Care Products Co., Ltd.

節亮康復產品有限公司





COMPANY PROFILE

公司簡介

Ziglite Smart Health Care Products Co., Ltd. incorporated in 2018, we work with our partners to bring their products to the local market. We mainly engaged in developing healthcare products, our main streams are hospitals and clinics, homes for the elderly, and home patients.

We develop excellent healthcare gadgets, intending to satisfy the needs of a wide range of customer groups, getting the best care in the family treatment process, and improving the effectiveness of rehabilitation. Get the best care during the family treatment process and improve the healing effect. We will provide quality products with stable quality and performance for customers.

We specialize in a wide range of products including anti-virus and air freshening, incontinence care, mobility aids, decompression supplies, etc.

YOUR SMART HEALTH CARE
SOLUTION PARTNERS



公司於2018年成立，我們與合作夥伴一起把他們的產品推向本地市場。以經營康護用品為主，主要客戶為醫院及診所，安老院及家居病人等。

我們致力於發展卓越的康護醫療產品，竭誠照顧廣大不同客戶的需要，在家庭治療過程中得到最好的護理，大大提高康復治療效果。在家庭治療過程中得到最好的護理，大大提高康復治療效果。務求為客戶提供品質優越及性能穩定的醫療產品。

我們專營的產品種類繁多，包括：抗病毒及空氣清新，失禁護理，助行用品，減壓用品等。



UVC 消毒殺菌燈消毒殺菌燈

UVC Antivirus Sterilizer

P1

UVC Antivirus Sterilizer
UVC殺菌消毒燈系列

P1

UVC Application Products
UVC應用產品

P19

Air Purification
空氣淨化

P34



健康測試儀

Health Test Meter

P41

Temperature Tester
溫度測試儀

P41

Blood Pressure & Oxygen Detection
血壓/血氧測試儀

P44

Other Health Tests
其他健康測試

P52



飲食改善

Eating Improver

P55

Food Aid Tableware
助食餐具

P55



康復產品

Rehab Products

P60

Rehabilitation Training For Limbs
上下肢康復訓練

P60

Rehabilitation Training For Hand
手部康復訓練

P68



運動防護

Sports Protective Gear

P73

Hand Protection
手部防護

P73

Lower Limb Protection
下肢防護

P79

Other Protection
其他防護

P85



牽引裝置

Traction Devices

Cervical Vertebra Traction Device
頸椎牽引

P89

P89

Thoracic & Lumbar Traction Device
胸&腰椎牽引

P98

Arm & Shoulder Traction Device
手臂&肩部支撐牽引

P107

Hand Fixing Supporter
手部固定支撐

P117

Lower Limb Traction Device
下肢牽引

P132

Foot Fixing Supporter
足部固定支撐

P143

智能按摩器

Intelligent Massager

Intelligent Massager
智能按摩器

P151

P151

Graphene series
石墨烯系列

P159

Physical massager
物理按摩器

P164

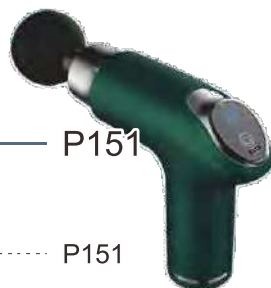

助行器系列

Walking Assist Series

Wheelchair & Walking Aids
輪椅&助行器

P167

P167

Crutches
拐杖

P171

Handrail & Potty Chair
扶手&坐便椅

P177



護理用品

Health Care Products

Limb Fixation
肢體固定

P180

P180

Posture Cushion
體位墊

P183

Incontinence Care Products
失禁護理

P187

Other Care Products
其他護理

P191



LED UV Anti-virus Lamp

LED紫外線殺毒棒 (3燈)



3 deep UV LED beads, the sterilization rate was 99.9%
3顆深紫外LED燈珠, 殺菌率為99.9%
10 second intelligent timing disinfection
10秒智能定時消毒

Small and light, easy to carry
小巧輕便, 易攜帶

One key switch, easy to operate
一鍵開關, 操作方便



- Product Material 產品材質 / ABS
Power 功率 / 1.5W
Wavelength 波長 / UVC 270-280nm UVA 390-405nm
Number of LED lamp LED 燈珠數量 / 3pcs UVC LED
Power supply 電源供應 / USB charging/18650 lithium battery
USB充電/ 18650鋰電池
- Disinfection time 消毒時間 / 10S(定時)
Size 尺寸 / 140*35*25mm
Weight 重量 / 87g

UVC Antivirus Lamp Series

UVC殺菌消毒燈系列

LED Ultraviolet Antivirus Stick

LED紫外線殺毒棒 (8燈)



智能定時 UVC LED 重力感應



8 deep UV LED beads, the sterilization rate was 99.9%
8顆深紫外LED燈珠,殺菌率為99.9%

10 second intelligent timing disinfection
10秒智能定時消毒

Gravity induction reverse protection: when working, when the lamp bead is turned upside down > 90°, the light will be automatically turned off to protect the human body from the light. When it is downward again, it will start working

重力感應反向保護: 工作時, 燈珠反向朝上 >90° 時, 燈光會自動關閉, 保護人體不被燈光照射, 把UVC燈向下時繼續開始工作

Child lock protection with intimate design
貼心兒童鎖保護設計



- Product Material 產品材質 / ABS
Power 功率 / 4W
Wavelength 波長 / 260-280nm
Number of LED lamp LED 燈珠數量 / 8pcs UVC LED
Power supply 電源供應 / USB charging/18650 lithium battery
USB充電/18650鋰電池
- Disinfection time 消毒時間 / 10S(定時)
Size 尺寸 / 265*40*25mm
Weight 重量 / 160g

Folding LED Ultraviolet Antivirus Stick

折疊式LED紫外線殺毒棒 (16燈)



智能定時 UVC LED 重力感應



Folding design, easy to carry
折疊設計, 攜帶方便

16 deep UV LED beads, the sterilization rate was 99.9%
16顆深紫外LED燈珠,殺菌率為99.9%

Gravity induction reverse protection: when working, when the lamp bead is turned upside down > 90°, the light will be automatically turned off to protect the human body from the light. When it is downward again, it will start working

重力感應反向保護: 工作時, 燈珠反向朝上 >90° 時, 燈光會自動關閉, 保護人體不被燈光照射, 把UVC燈向下時繼續開始工作

Child lock protection with intimate design
貼心兒童鎖保護設計

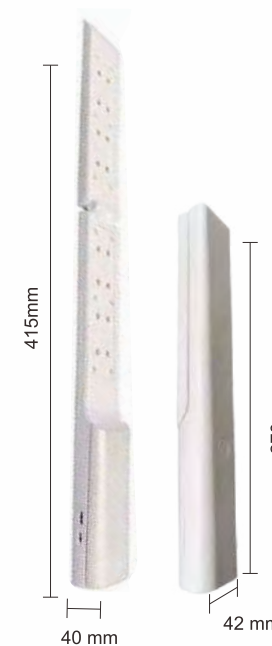

- Product Material 產品材質 / ABS
Power 功率 / 9W
Wavelength 波長 / 260-280nm
Number of LED lamp LED 燈珠數量 / 16pcs UVC LED
Power supply 電源供應 / USB charging/18650 lithium battery
USB充電/18650鋰電池
- Disinfection time 消毒時間 / 10S(定時)
Size 尺寸 / 270 * 42 * 40mm
Weight 重量 / 198g

Mini UV Anti-virus Lamp

迷你紫外線殺毒燈



UVC LED 小巧便攜

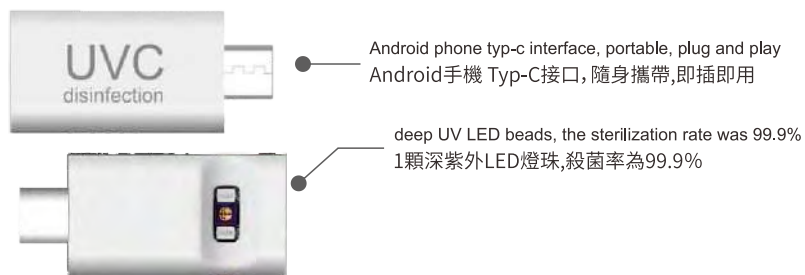

Android phone typ-c interface, portable, plug and play
Android手機 Typ-C接口, 隨身攜帶, 即插即用

deep UV LED beads, the sterilization rate was 99.9%
1顆深紫外LED燈珠, 殺菌率為99.9%



UVC LED 小巧便攜

APPLE phone interface, portable, plug and play
APPLE 手機接口, 隨身攜帶, 即插即用

1 deep UV LED bead, the sterilization rate was 99.9%
1顆深紫外LED燈珠, 殺菌率為99.9%



- Product Material 產品材質 / ABS
Power 功率 / 0.45W
Wavelength 波長 / 260-280nm
LED lamp LED 燈珠 / 1 pc UVC LED+2pcs Fill LED
Power supply 電源供應 / Input: APPLE DC3.7V, type-C DC5V
Output: APPLE DC6V, type-C DC6V
- Size 尺寸 / 30*14*7mm
Weight 重量 / 3g

LED UV Anti-virus Lamp

輕便手持LED紫外線殺毒燈 (1燈)



智能定時 UVC LED 小巧便攜



1 deep UV LED beads, the sterilization rate was 99.9%
1顆深紫外LED燈珠, 殺菌率為99.9%

Automatic timing mode works for 60s and automatic shutdown;
manual timing mode works for 30min and automatic shutdown
自動定時模式工作60s自動關機, 手動定時工作30分鐘
自動關機

One key switch, easy to operate
一鍵開關, 操作方便

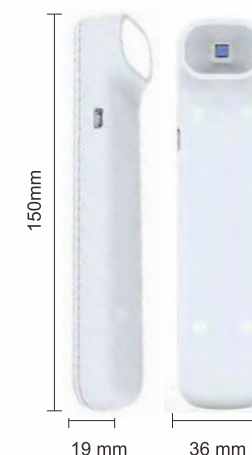

- Product Material 產品材質 / ABS
Power 功率 / 3W
Wavelength 波長 / 260-280nm
LED lamp LED 燈珠 / 1 pc UVC LED
Power supply 電源供應 / USB charging / 500mAh
- Working time 工作時間 / 60s/30 min (self-power off)
Size 尺寸 / 150*35*19mm
Weight 重量 / 80g

G1 LED Folding UVC Disinfection Stick

G1 LED 折疊式紫外線消毒棒



智能定時 UVC LED 重力感應



Folding design, easy to carry
折疊設計, 攜帶方便

16 deep UV LED beads, the sterilization rate was 99.9%
16顆紫外線LED燈珠, 殺菌率為99.9%

Gravity induction reverse protection: when working, when the lamp bead is turned upside down > 90°, the light will be automatically turned off to protect the human body from the light. When it is downward again, it will start working

重力感應反向保護: 工作時, 燈珠反向朝上 >90° 時, 燈光會自動關閉, 保護人體不被燈光照射, 把UVC燈向下時繼續開始工作

Child lock protection with intimate design
貼心兒童鎖保護設計

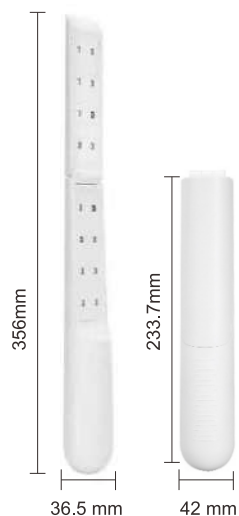

- Product Material 產品材質 / ABS
Power 功率 / 7W
Wavelength 波長 / 260-280nm
LED lamp LED 燈珠 / 4pcs UVC +12pcs UVA LED
Power supply 電源供應 / TYPE-C/2000 mAh
- Disinfection time 消毒時間 / 10S(定時)
Size 尺寸 / 356*36.5 * 42 mm
Weight 重量 / 160g

Portable LED UVC Sterilizing Lamp

便攜式手持LED UVC殺毒燈



智能定時 UVC LED 重力感應



3 deep UV LED beads, the sterilization rate was 99.9%
3顆深紫外LED燈珠, 殺菌率為99.9%

Gravity induction reverse protection: when working, when the lamp bead is turned upside down > 90°, the light will be automatically turned off to protect the human body from the light. When it is downward again, it will start working

重力感應反向保護: 工作時, 燈珠反向朝上 >90° 時, 燈光會自動關閉, 保護人體不被燈光照射, 把UVC燈向下時繼續開始工作

One key switch, easy to operate
一鍵開關, 操作方便

Intelligent shutdown after working for 5 minutes
工作5分鐘智能關閉

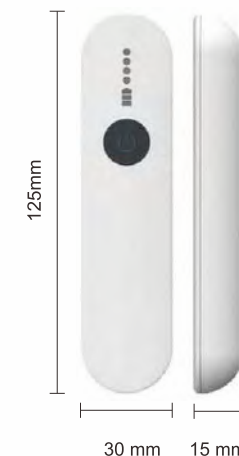

- Product Material 產品材質 / ABS
Power 功率 / 1W
Wavelength 波長 / 260-275nm
LED lamp LED 燈珠 / 1 pc UVC LED+2pcs LED
Power supply 電源供應 / USB charging/400mAh
- Working time 工作時間 / 5 min (self-power off)
Size 尺寸 / 125 * 30 * 15mm
Weight 重量 / 33g

Portable LED UVC Sterilizing Lamp

便攜式手持LED UVC殺毒燈



2 deep UV LED beads, the sterilization rate was 99.9%
2顆紫外線LED燈珠,殺菌率為99.9%

Gravity induction reverse protection: when working, when the lamp bead is turned upside down > 90°, the light will be automatically turned off to protect the human body from the light. When it is downward again, it will start working

重力感應反向保護: 工作時, 燈珠反向朝上 >90° 時, 燈光會自動關閉, 保護人體不被燈光照射, 把UVC燈向下時繼續開始工作

One key switch, easy to operate
一鍵開關, 操作方便



Work racing light indication
工作時跑馬燈指示



- Product Material 產品材質 / ABS
Power 功率 / 1.2W
Wavelength 波長 / 270-275nm
LED lamp LED 燈珠 / 2pcs UVC LED
Power supply 電源供應 / USB/200 mAh
- Disinfection time 消毒時間 / 10s-300s
Size 尺寸 / 120*30*25mm
Weight 重量 / 33g

Portable LED UVC Sterilizing Lamp

便攜式手持LED UVC殺毒燈



1 deep UV LED beads, the sterilization rate was 99.9%
1顆深紫外LED燈珠,殺菌率為99.9%

Digital display of working hours
工作時間數字顯示

Press 3 seconds to start, one key disinfection, simple operation
按3秒啟動, 一鍵消毒, 操作簡單

Compact and portable
小巧輕便, 便攜隨行

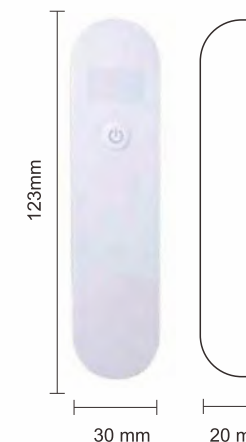

- Product Material 產品材質 / ABS
Working voltage 工作電壓 / 3.7V/1A
Wavelength 波長 / 260~275nm
LED lamp LED 燈珠 / 1 pc UVC LED
Power supply 電源供應 / USB charging/500mAh
- Working time 工作時間 / 10s-300s
Size 尺寸 / 123*30*20mm
Weight 重量 / 33g

Intelligent Ultraviolet Sterilization Wardrobe Lamp

智能紫外线杀菌衣橱灯

CZ



智能定时 UVC LED 人體感應



Intelligent human body sensing, automatically turn on the lighting when sensing a person, and automatically turn off the lighting after the person walks to start disinfection

智能人體感應，人來自動開啟照明，人走自動關閉照明，開始消毒

5 deep UV LED beads, the sterilization rate was 99.9%
5顆紫外線LED燈珠，殺菌率為99.9%

Lasting 15 minutes, intelligent timed UVC disinfection
持續15分鐘智能定時UVC消毒

Intelligent protection: during disinfection, stop disinfection when people come, and continue to disinfect after people wait for 30s

智能防護：人來停止消毒，人走30s後繼續開始消毒

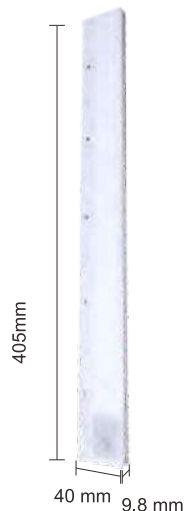

● Product Material 產品材質 / ABS

Power 功率 / 1W

Wavelength 波長 / UVC (270-280nm) +UVA (395-405nm)

LED lamp LED 燈珠 / 5pcs UVC LED + Lighting LED

Power supply 電源供應 / Polymer lithium ion battery 3.7V/1.8Ah
聚合物鋰離子電池 3.7V/1.8Ah

● Disinfection time 消毒時間 / 15 min

Sensing distance 感應距離 / 1-2m

Size 尺寸 / 405*40*9.8 mm

Weight 重量 / 150g

Hand Held UV Anti-virus Lamp (Mercury Lamp Type)

手持紫外线殺毒燈(汞燈)

CAK



手持便攜 UVC 殺菌 重力感應



High quality ultraviolet lamp, with a sterilization rate of 99.9%
優質紫外線燈管，殺菌率為99.9%

Gravity induction reverse protection: when working, when the lamp bead is turned upside down > 90°, the light will be automatically turned off to protect the human body from the light. When it is downward again, it will start working

重力感應反向保護：工作時，燈珠反向朝上 >90° 時，燈光會自動關閉，保護人體不被燈光照射，把UVC燈向下時繼續開始工作

One key switch, easy to operate
一鍵開關，操作方便

Battery powered, convenient and portable
電池供電，方便便攜

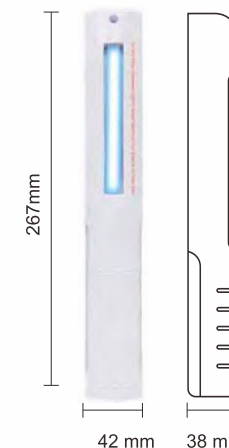

● Product Material 產品材質 / ABS

Power 功率 / 3W

Wavelength 波長 / 253.7nm

Lamp 燈 / Mercury lamp 汞燈

Power supply 電源供應 / Four AA batteries
四節AA電池

● Disinfection time 消毒時間 / 30s-3 min

Size 尺寸 / 267*38*42mm

Weight 重量 / 136g

Folding UV Antivirus Lamp

折疊式紫外線殺毒燈



摺疊便攜 UVC 殺菌 重力感應

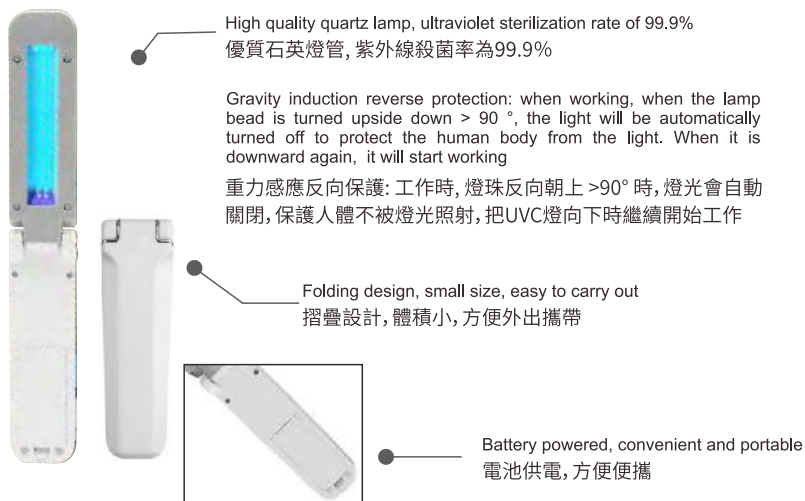

High quality quartz lamp, ultraviolet sterilization rate of 99.9%
優質石英燈管, 紫外線殺菌率為99.9%

Gravity induction reverse protection: when working, when the lamp bead is turned upside down > 90°, the light will be automatically turned off to protect the human body from the light. When it is downward again, it will start working

重力感應反向保護: 工作時, 燈珠反向朝上 >90° 時, 燈光會自動關閉, 保護人體不被燈光照射, 把UVC燈向下時繼續開始工作

Folding design, small size, easy to carry out
摺疊設計, 體積小, 方便外出攜帶

Battery powered, convenient and portable
電池供電, 方便便攜

- Product Material 產品材質 / ABS
Power 功率 / 2.5 W
Wavelength 波長 / 253.7 nm
Power supply 電源供應 / 4 *AAA battery or USB power supply
4*AAA電池或者USB電源
- Disinfection time 消毒時間 / 30s-3 min
Size 尺寸 / 240*38*25 mm
Weight 重量 / 150g

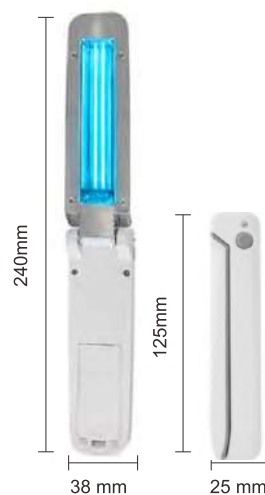

Portable UVC Stick Anti-virus Lamp

便攜式紫外線UVC棒式殺毒燈



手持便攜 UVC 殺菌

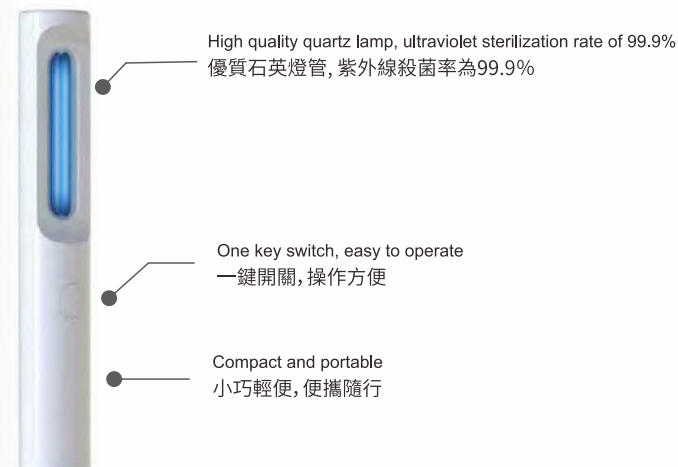

High quality quartz lamp, ultraviolet sterilization rate of 99.9%
優質石英燈管, 紫外線殺菌率為99.9%

One key switch, easy to operate
一鍵開關, 操作方便

Compact and portable
小巧輕便, 便攜隨行

- Product Material 產品材質 / ABS
Power 功率 / 5W
Wavelength 波長 / 253.7nm
Lamp 燈 / Mercury lamp 汞燈
Power supply 電源供應 / USB charging/400mAh
- Disinfection time 消毒時間 / 30-180s
Size 尺寸 / 200*31*31mm
Weight 重量 / 75g



Portable UV Anti-virus Lamp

便捷式紫外線殺菌燈



定時殺菌 360° 殺菌 小巧輕便



High quality quartz lamp, ultraviolet sterilization rate of 99.9%
優質石英燈管, 紫外線殺菌率為99.9%

Intelligent timing sterilization for 30 minutes
智能定時殺菌30分鐘

Small size, easy to carry
體積小, 攜帶方便

One key switch, easy to operate
一鍵開關, 延遲30s自動開始殺菌



- Product Material 產品材質 / ABS
Power 功率 / 3.8 W
Wavelength 波長 / 253.7 nm
Lamp 燈 / Quartz glass tube 石英玻璃管
Power supply 電源供應 / USB power supply/1000mAh
USB電源/1000毫安電池
- Disinfection time 消毒時間 / 30 min
Applicable area 適用面積 / 3-5m²
Size 尺寸 / 120*56*56 mm
Weight 重量 / 100g

UVC Induction Germicidal Lamp With British Bracket

帶英式支架UVC感應殺菌燈



定時殺菌 360° 殺菌 微波感應

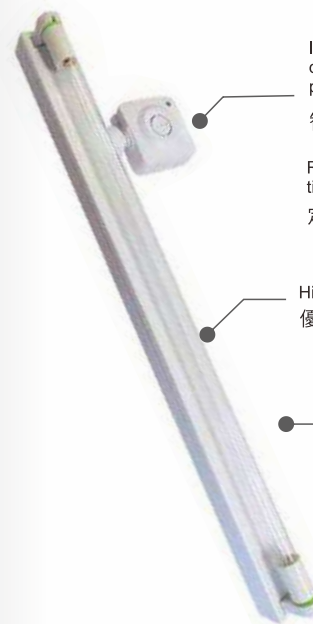

Intelligent human microwave induction, automatic suspension of disinfection when people come, automatic start of disinfection when people walk

智能人體微波感應, 人來自動暫停消毒, 人走自動開始消毒

Regular disinfection and sterilization, disinfection time and delay waiting time can be set as required

定時消毒殺菌, 消毒時間, 延遲等待時間均可按需設置

High quality quartz lamp, ultraviolet sterilization rate of 99.9%
優質石英燈管, 紫外線殺菌率為99.9%

With bracket for easy installation
帶支架, 便於安裝

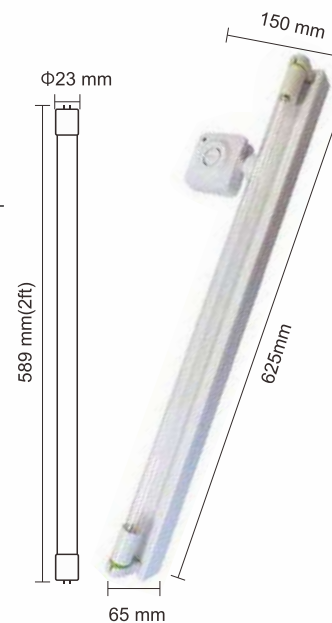

- Product Material 產品材質 / ABS
Power 功率 / 20W
Wavelength 波長 / 253.7nm
Lamp 燈 / Quartz glass tube 石英玻璃管
Power supply 電源供應 / AC 220-240V
Lamp Base 燈腳 / T8,G13
- Disinfection time 消毒時間 / 15min/30min/1H/24H(Set)
Applicable area 適用面積 / 20m²
Size 尺寸 / tube φ23*589mm
with bracket 625 * 150 * 65mm
Weight 重量 / 550g

Double Bracket Induction UVC Disinfection Lamp

雙支架感應紫外線消毒燈

FE



定時殺菌 360° 殺菌 微波感應

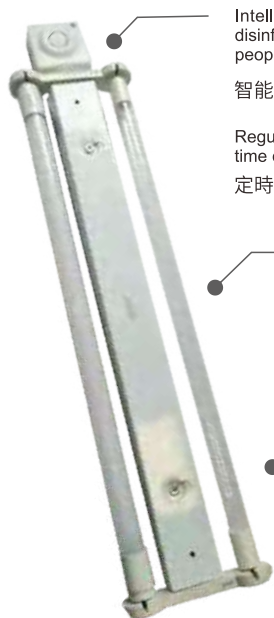

Intelligent human microwave induction, automatic suspension of disinfection when people come, automatic start of disinfection when people walk

智能人體微波感應，人來自動暫停消毒，人走自動開始消毒

Regular disinfection and sterilization, disinfection time and delay waiting time can be set as required

定時消毒殺菌，消毒時間，延遲等待時間均可按需設置

High quality quartz lamp, ultraviolet sterilization rate of 99.9%
優質石英燈管，紫外線殺菌率為99.9%

4000K long light LED tube, soft natural light, no stroboscopic, no eye injury
4000k 長亮LED照明燈管，柔和自然光，無頻閃不傷眼

With bracket for easy installation
帶支架，便於安裝

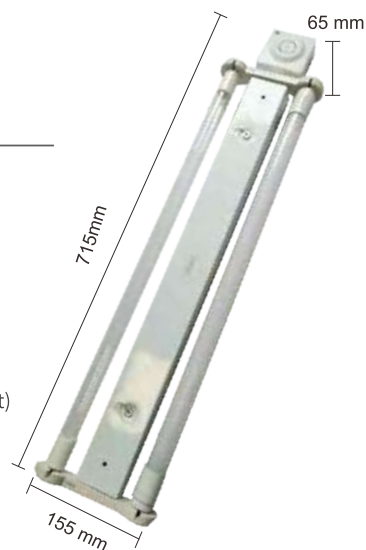

- Product Material 產品材質 / ABS
Power 功率 / 9W+20W
Wavelength 波長 / 253.7nm
UVC tube UVC燈管 / Quartz glass tube 石英玻璃管
Power supply 電源供應 / AC 220-240V
Lamp Base 燈腳 / T8,G13
- Disinfection time 消毒時間 / 15min/30min/1H/24H(Set)
Applicable area 適用面積 / 20m²
Size 尺寸 / UVC tube φ23*589mm
with bracket 715*155*65mm
Weight 重量 / 1150g

E27 Screw UVC + Ozone Disinfection Lamp

E27螺口紫外線+臭氧消毒燈

CAO



微波感應 360° 殺菌 遙控控制



High quality quartz lamp, ultraviolet sterilization rate of 99.9%
優質石英燈管，紫外線殺菌率為99.9%

High power, wider sterilization range
大功率，殺菌範圍更大



Integrated design, with special socket, easy to use
一體化設計，配專用插座，使用方便



Equipped with wireless through wall remote control, easy to operate
配置無線穿牆遙控器，操作方便

- Product Material 產品材質 / ABS
Power 功率 / 38W
Wavelength 波長 / 185nm+253.7nm
Lamp 燈 / Quartz glass tube 石英玻璃管
Power supply 電源供應 / AC 220-240V
Lamp Base 燈腳 / E27
- Applicable area 適用面積 / 20-40m²
Size 尺寸 / φ63*278.3mm
Weight 重量 / 400g





Disinfection Household Articles 消毒類生活用品

UVC Toothbrush Sterilizer

紫外線牙刷消毒器



智能定時 360° 殺菌 開蓋保護



- Product Material 產品材質 / ABS
Power 功率 / 3W
Wavelength 波長 / 253.7nm
Lamp 燈 / Quartz glass tube 石英玻璃管
Power supply 電源供應 / USB charging /1500mAh
USB充電/1500毫安
- Disinfection time 消毒時間 / 360S
Size 尺寸 / 200*75*40mm
Weight 重量 / 200g

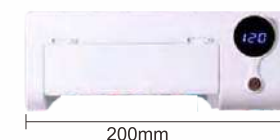

Portable UVC Toothbrush Sterilizer

可攜式紫外線牙刷消毒器



定時殺菌 UVC 殺菌 開蓋保護 小巧便攜



Cover opening protection design: stop working when the cover is opened to prevent direct ultraviolet light
 開蓋保護設計: 開蓋停止工作, 防止紫外光線直射傷害人體

Compact and portable
 小巧輕便, 便攜隨行

2 deep UV LED beads, the sterilization rate was 99.9%
 2顆紫外線LED燈珠, 殺菌率為99.9%

The box cover can be sterilized, 60s intelligent timing close, and automatically start sterilization every 6 hours
 盒蓋即可殺菌, 60s智能定時關閉, 每6小時自動啟動殺菌



- Product Material 產品材質 / PC+ABS
 Power 功率 / 1 W
 Wavelength 波長 / UVC+UVA 260-380nm
 Power supply 電源供應 / USB charging/450mAh

- Disinfection time 消毒時間 / 60s
 Size 尺寸 / 55*68*42 mm
 Weight 重量 / 56g

Portable UVC Toothbrush Sterilizer

可攜式紫外線牙刷消毒器



智能定時 360° 殺菌 開蓋保護 小巧便攜



Cover opening protection design: stop working when the cover is opened to prevent direct ultraviolet light
 開蓋保護設計: 開蓋停止工作, 防止紫外光線直射傷害人體

Compact and portable
 小巧輕便, 便攜隨行

3 deep UV LED beads, the sterilization rate was 99.9%
 3顆紫外線LED燈珠, 殺菌率為99.9%

The box cover can be sterilized, 60s intelligent timing close, and automatically start sterilization every 6 hours
 盒蓋即可殺菌, 60s智能定時關閉, 每6小時自動啟動殺菌



- Product Material 產品材質 / PC+ABS
 Power 功率 / 5W
 Wavelength 波長 / UVC+UVA 260-380nm
 Power supply 電源供應 / USB charging/450mAh

- Disinfection time 消毒時間 / 60s
 Size 尺寸 / 75*68*42mm
 Weight 重量 / 72g

UVC Sterilizer Box

UVC紫外線消毒盒



定時殺菌 360°殺菌 密封設計



One button operation, simple and convenient
一鍵操作, 簡單方便

Disinfect and sterilize regularly for 300 seconds
300秒定時殺菌, 殺菌率99.9%



Fully sealed design, 360 degree all-round sterilization, no dead angle
完全密封設計, 360度全方位殺菌, 無死角

0.95l large capacity, masks, toothbrushes, jewelry, pacifiers, etc. can be used
0.95L大容量, 口罩、牙刷、珠寶、奶嘴等均可使用



- Product Material 產品材質 / 30%PC+ABS
Power 功率 / 2*1 W
Wavelength 波長 / 253.7nm
Power supply 電源供應 / USB charging
Maximum Capacity 最大容量 / 9.5L

- Disinfection time 消毒時間 / 300s
Size 尺寸 / 266*149*70 mm
Weight 重量 / 300g

Multifunctional UVC Disinfection Box

多功能紫外線消毒盒



智能定時 360°殺菌 開蓋保護 重力感應



One key operation, 360 second timing, automatic sterilization
一鍵操作, 360秒計時, 自動殺菌

UVC disinfection stick can be disassembled and used more flexibly
UVC消毒棒可以拆卸, 使用更靈活

UVC消毒棒可以拆卸, 使用更靈活

The sterilizing rod is designed by gravity induction, with inclination > 60°, and automatically stops working
消毒棒採用重力感應設計, 傾斜度>60°, 自動停止工作



5 deep UV LED beads, the sterilization rate was 99.9%
5顆紫外線LED燈珠, 殺菌率為99.9%

Cover opening protection design: stop working when the cover is opened to prevent direct ultraviolet light
開蓋保護設計: 開蓋停止工作, 防止紫外光線直射傷害人體



- Product Material 產品材質 / ABS
Power 功率 / 3W
Wavelength 波長 / UVC 260-280nm
Power supply 電源供應 / USB charging

- Disinfection time 消毒時間 / 360s
Size 尺寸 / 235 * 131 * 80 mm
Weight 重量 / 365g

Portable UVC Folding Disinfection Bag

便攜UVC折疊消毒包



定時殺菌 360°殺菌 開蓋保護



One key operation, simple and convenient
一鍵操作, 簡單方便

Rapid sterilization in 3 minutes, with a sterilization rate of 99.9%
3分鐘快速消毒, 殺菌率99.9%

Switch balance protection, open the cover 30° and automatically turn off the ultraviolet light to prevent ultraviolet radiation from hitting the eyes
開關平衡保護, 開蓋30°角自動關閉紫外線光, 防止紫外線照射到眼睛

開關平衡保護, 開蓋30°角自動關閉紫外線光, 防止紫外線照射到眼睛



Collapsible storage, does not take up space
可摺疊收納, 不占用空間

Fully sealed design, 360 degree all-round sterilization, no dead angle
完全密封設計, 360度全方位殺菌, 無死角

● Product Material 產品材質 / 600D雪花料+環保鋁箔

Power 功率 / 1.5 W

Wavelength 波長 / 265-280nm

Power supply 電源供應 / USB charging



● Disinfection time 消毒時間 / 180s

Size 尺寸 / 240*170*140 mm

Weight 重量 / 431g

Hand Held Bed Ultraviolet Sterilizer

手持床上紫外線殺菌除蟎儀



一鍵操作 消毒殺菌 高頻拍打



One key operation, simple and convenient
一鍵操作, 簡單方便

85000 RPM high speed motor, super suction
8.5萬轉高速馬達 超強吸力

Strong double head tapping, high frequency tapping, more thorough cleaning effect
強力雙頭拍打, 高頻率拍打, 清潔效果更徹底

強力雙頭拍打, 高頻率拍打, 清潔效果更徹底



UVC sterilization, UC lamp automatically turns off when it is not working to avoid injury to human body
UVC殺菌, 不工作時UC燈自動關閉, 避免傷害人體



250 mm

● Product Material 產品材質 / ABS

Power 功率 / 3W

Wavelength 波長 / 253.7nm+185nm

Power supply 電源供應 / AC 220v



290 mm

● Disinfection time 消毒時間 / 360s

Size 尺寸 / 340*250*290mm

Weight 重量 / 1750g

340 mm

Shoe Drying Sterilizer 鞋子烘乾消毒器

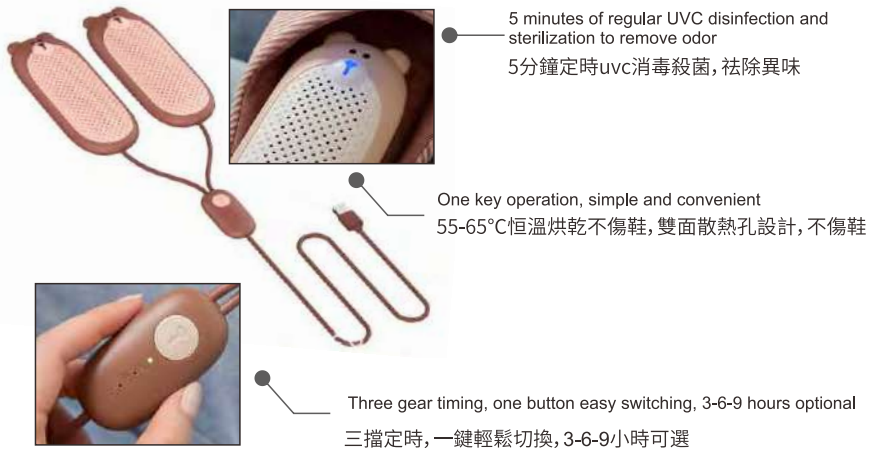

- Product Material 產品材質 / ABS+PC+PP
Power 功率 / 10 W
Wavelength 波長 / 270-285nm
Power supply 電源供應 / USB
Temperature 發熱溫度 / 55~65°C
- Working hours 工作時間 / 3/6/9H
Size 尺寸 / 174*66*27 mm
Weight 重量 / 350g

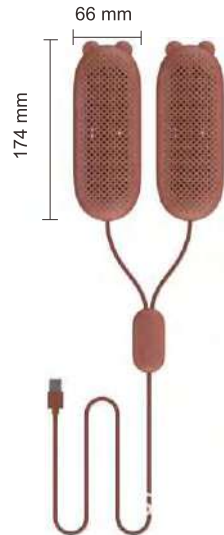

Portable UV Electric Shock Mosquito Killing Lamp 便攜UV電擊式滅蚊燈



- Product Material 產品材質 / ABS+SUS鍍鎳電網
Power 功率 / 5W
Wavelength 波長 / 360-375nm
Power supply 電源供應 / DC 5V
- Applicable area 適用面積 / 20-50m²
Size 尺寸 / 100*100*190mm
Weight 重量 / 270g



Ultraviolet Electric Mosquito Swatter

紫外誘蚊電蚊拍



角度可調節 誘蚊滅蚊 安全設計

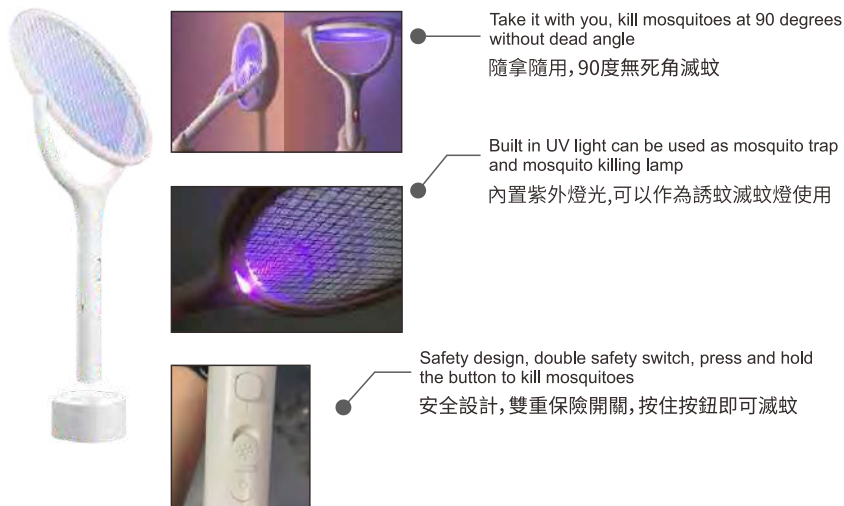

Take it with you, kill mosquitoes at 90 degrees without dead angle
隨拿隨用, 90度無死角滅蚊

Built in UV light can be used as mosquito trap and mosquito killing lamp
內置紫外燈光, 可以作為誘蚊滅蚊燈使用

Safety design, double safety switch, press and hold the button to kill mosquitoes
安全設計, 雙重保險開關, 按住按鈕即可滅蚊

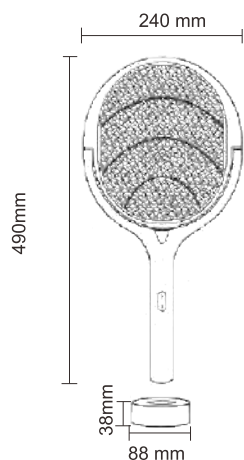

- Product Material 產品材質 / ABS+PC+鍍銀鐵網
Wavelength 波長 / 360-375nm
Power supply 電源供應 / USB charging/1800mAh
Temperature 工作溫度 / 30°C
Rotation angle 旋轉角度 / 0-90°

- Applicable area 適用面積 / 20-50m²
Size 尺寸 / 240*490* 30mm
Weight 重量 / 260g

Wall Mounted Infrared Induction Washing Machine

壁掛式紅外感應洗手機



紅外感應 定量出液 智能噴灑



Manual wall mounting can also be installed with 3M glue, with simple operation
手動壁掛安裝也可以用3M膠安裝, 操作簡單

Large capacity liner, 1000ml large capacity, no need to change liquid frequently
大容量內膽, 1000ml大容量, 不用頻繁換液

Intelligent sensing, zero contact, avoid cross infection
智能感應, 零接觸, 避免交叉感染的發生

- Product Material 產品材質 / ABS
Wavelength 容量 / 1000ml
Outlet mode 出液方式 / Induction atomization 感應霧化
Power supply 電源供應 / 4°C batteries / DC power supply

- Size 尺寸 / 130*127*270mm
Weight 重量 / 926g



Infrared Sensor Hand Washing Machine

紅外自動感應洗手器



紅外感應 定量出液 智能噴灑



Infrared sensing, small waist design, touch switch, convenient sterilization
紅外感應, 小蠻腰設計, 觸控開關, 殺菌方便

Inclined mouth 30 degrees, reach out and avoid touching the body
斜嘴30度, 伸手即可, 避免觸碰機身

500ml capacity, scientific and reasonable control of liquid output, saving consumption and avoiding waste
500ml容量, 科學合理控制出液量, 節省用量, 避免浪費

Applicable disinfectant: 84 disinfectant, 75% alcohol, hypochlorous acid disposable disinfectant
適用消毒液: 84消毒液, 75%酒精, 次氯酸免洗消毒液



- Product Material 產品材質 / ABS+PP
Wavelength 容量 / 500ml
Outlet mode 出液方式 / Induction atomization 感應霧化
Power supply 電源供應 / 4*AAA batteries

- Size 尺寸 / 105*87*205mm
Weight 重量 / 250g

Infrared Automatic Sensing Foam Washing Machine

紅外自動感應泡沫洗手機



紅外感應 定量出液 智能出泡



Infrared sensing, small waist design, touch switch, convenient sterilization
紅外感應, 零接觸, 避免交叉感染的發生



45° angle blistering: natural fit, easy to reach, avoid machine sticking
45°傾角出泡: 自然貼合, 伸手不累, 避免機器粘機

Transparent liquid storage, easy to see the contents, no difficulty in adding liquid
透明儲液倉, 輕鬆看到內容物, 加液無困難



- Product Material 產品材質 / ABS
Wavelength 容量 / 400ml
Outlet mode 出液方式 / Sensing foam 感應出泡沫
Power supply 電源供應 / DC3.7v/USB charging

- Size 尺寸 / 205*75*110mm
Weight 重量 / 260g

Infrared Automatic Sensing Gel Washing Machine

紅外自動感應凝膠洗手機



Infrared sensing, small waist design, touch switch, convenient sterilization
紅外感應, 零接觸, 避免交叉感染的發生



Inclined liquid outlet: reach out to avoid touching the fuselage

傾角出液口: 伸手即可, 避免觸碰機身

450ml capacity, 0.25s rapid liquid discharge, two modes switching liquid volume, saving consumption and avoiding waste

450ml容量, 0.25s快速出液, 兩種模式切換液量, 節省用量, 避免浪費

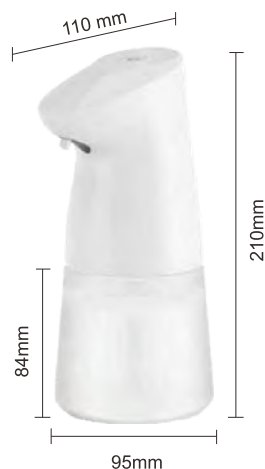

- Product Material 產品材質 / ABS+PET
Wavelength 容量 / 450ml
Outlet mode 出液方式 / Infrared sensing
Power supply 電源供應 / 4*AA batteries

- Size 尺寸 / 95*95*210mm
Weight 重量 / 226g



Air purification
空氣淨化

UV Air Purifier

紫外線空氣淨化器

FAQ



去除過敏原 360° 殺菌 淨化空氣



Built in ultraviolet ray, no escape sterilization, safe, efficient and thorough purification
內置紫外線, 無逃逸殺菌, 安全高效徹底淨化

USB ultra-low voltage power supply, safe without electric shock, short circuit without spontaneous combustion
USB超低壓電源, 安全無觸電, 短路不引起自燃

Compact and compact, no space, 35dB silent operation
精緻小巧, 不佔空間, 35dB靜音工作



180mm

Φ118mm

- Product Material 產品材質 / ABS
Power 功率 / 5 W
Wavelength 波長 / 265 nm
Power supply 電源供應 / USB power supply

- Applicable area 適用面積 / 3-5m²
Size 尺寸 / 118*118*180 mm
Weight 重量 / 500g

Negative Ion Desktop Air Purifier

負離子臺式空氣淨化器

FAQ



去除過敏原 產生負離子 淨化空氣



Purify air, absorb dust, particles, hair, pollen, deodorize, smoke, TVOC, etc
淨化空氣, 吸收灰塵、顆粒、頭髮、花粉、除臭、除煙、除TVOC等

Increase the oxygen content in the air and produce healthy ions
增加空氣中的氧含量並產生健康離子

Active carbon deodorization, which can fully filter PM2.5 and formaldehyde
活性炭除臭, 能充分過濾PM2.5和甲醛



125 mm

194 mm

- Product Material 產品材質 / ABS+PC
Power 功率 / ≤2W
Anion output 負離子產量 / 5×10⁶pcs/cm³
Power supply 電源供應 / USB, car power supply
USB, 車載電源

- Applicable area 適用面積 / ≤10m²
Size 尺寸 / 125*125*194mm
Weight 重量 / 520g

Portable Anion + Ozone Air Purifier

便攜式負離子+臭氧空氣淨化機



去除過敏原 負離子+臭氧 淨化空氣



- Purify air, sterilize, deodorize, and the concentration of negative ions reaches 160 million
淨化空氣, 殺菌, 除臭, 負離子濃度高達1.6億
- One button start, multiple mode selection:
two-stage negative ion mode, three-stage ozone mode,
negative ion ozone double effect mode
一鍵啟動, 多種模式選擇: 兩級負離子模式,
三級臭氧模式, 負離子臭氧雙效模式
- Exquisite and compact, no space, 10dB silent operation
精緻小巧, 不佔空間, 10dB靜音工作



66mm



100mm

98mm

- Product Material 產品材質 / ABS+PC
Power 功率 / $\leq 5W$
Active oxygen output 活氧輸出 / 100mg/h
Power supply 電源供應 / DC5V/USB 4000mAh
- Applicable area 適用面積 / 11-20m²
Size 尺寸 / 100*66*98mm
Weight 重量 / 280g

Ozone Sterilizer

臭氧消毒器



臭氧消毒 淨化空氣



- Ozone sterilization and odor removal, decomposition of formaldehyde and toluene
臭氧滅菌和去除異味, 分解甲醛, 甲苯

Ozone 360° all-round deodorization and sterilization
臭氧360°全方位除臭殺菌

- Single deodorization mode, circular deodorization mode,
dual mode, one button switch
單次除臭模式, 循環除臭模式雙模式一鍵切換



- Product Material 產品材質 / ABS + PC + silica gel
ABS + PC + 矽膠
Power 功率 / 3W
Ozone emission 臭氧排放 / 20mg/m³/H
1立方米, 1小時, 20毫克
Power supply 電源供應 / USB 1800mAh
- Applicable area 適用面積 / $\leq 10m^2$
Size 尺寸 / 115*115*43mm
Weight 重量 / 228g

Ozone Refrigerator Active Purifier

臭氧冰箱活性淨化器

FAL



殺菌除臭 淨化空氣



Remove residues, quickly deodorize, kill bacteria, and prolong freshness

祛除殘留, 快速除臭, 殺滅細菌, 延長保鮮

One button startup, farewell to odor, long-term use, no energy consumption, no secondary pollution

一鍵啟動, 告別異味, 長期使用, 無耗能, 無二次污染

Suitable for refrigerator, wardrobe, shoe cabinet and other spaces
適用於冰箱、衣櫃、鞋櫃等空間

- Product Material 產品材質 / ABS
Power 功率 / $\leq 0.5W$
Ozone output 臭氧輸出 / 5mg/h
Power supply 電源供應 / 4 AA batteries

- Applicable area 適用面積 / 3-5m²
Size 尺寸 / 93*93*96mm
Weight 重量 / 150g



Portable Ultraviolet Air Purifier

便攜式紫外線空氣淨化器

CBD



紫外線消毒 淨化空氣



UVC sterilization, photocatalyst deodorization and antifouling 99.9% bactericidal rate

UVC殺菌, 光觸媒除臭抗污, 99.9%殺菌率

Vortex active circulation sterilization, disinfection and purification
渦流式主動循環殺菌, 邊消毒邊淨化

Portable design, plug in and use, applicable to all indoor occasions

便攜設計, 隨插隨用, 適用室內各個場合

- Product Material 產品材質 / ABS
Power 功率 / 4.5W
Power supply 電源供應 / USB

- Applicable area 適用面積 / $\leq 10m^2$
Size 尺寸 / 190*65*65mm
Weight 重量 / 225g

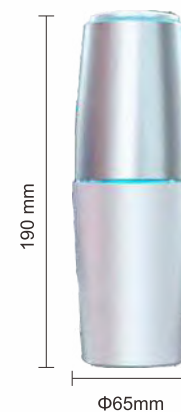



Temperature Tester

溫度測試儀

Non-Contact Infrared Thermometer

非接觸式紅外線溫度計

FAA



0.5s



紅外感應 快速測量 高溫警報



- Non contact infrared measurement, 0.5 second fast measurement
非接觸紅外量測, 0.5秒快速量測

- Multiple groups of memory values can be memorized at any time to easily master the temperature change
多組記憶值可隨時記憶, 輕鬆掌握體溫變化

- Product material 產品材質 / ABS
Measuring range 測溫範圍 /
Body temperature 身體溫度 : 32 ~ 43°C
Ambient temperature 環境溫度 : 0 ~ 100°C
Power supply 電源供應 / 2*AAA battery
Measuring distance 測量距離 / 1-5cm
Weight 重量 / 100g

FAH



0.5s



紅外感應 快速測量 高溫警報



- Non contact infrared measurement, 0.5 second fast measurement
非接觸紅外量測, 0.5秒快速量測
- Save 32 groups of memories, and easily master the temperature change
保存32組記憶, 輕鬆掌握體溫變化
- Green display: normal, red display: unqualified alarm, high temperature alarm
綠色顯示: 正常, 紅色顯示: 不正常, 高溫警報

- Product material 產品材質 / ABS
Measuring range 測溫範圍 / 10~40°C
Accuracy 精度 / ±0.2°C
Power supply 電源供應 / 2*AAA battery
Measuring distance 測量距離 / 3-5cm
Weight 重量 / 92g

Non-Contact Infrared Automatic Thermometer

非接觸式紅外線自動溫度計



- Infrared sensor, high precision, supporting outdoor measurement
紅外感測器, 精度高, 支持室外測量
- Wall hanging, bracket and pasting
壁掛, 支架, 粘貼三種固定方式
- Green display: normal, red display: unqualified alarm, high temperature alarm
綠色顯示: 正常, 紅色顯示: 不正常, 高溫警報

- Product material 產品材質 / ABS
Measuring range 測溫範圍 / 32.0-42.9°C
Power supply 電源供應 / USB
Measuring distance 測量距離 / 3-5cm
Weight 重量 / 263.5g



- Non contact infrared measurement, 1 second fast measurement
非接觸紅外量測, 1秒快速量測
- Fast installation, supporting magnetic suction, wall hanging and tripod installation
快捷安裝, 支持磁吸、掛牆、三腳架安裝
- Green display: normal, red display: unqualified alarm, high temperature alarm
綠色顯示: 正常, 紅色顯示: 不正常, 高溫警報

- Product material 產品材質 / ABS
Measuring range 測溫範圍 / 32-42°C(89.6-107.6°F)
Accuracy 精度 / $\pm 0.2^{\circ}\text{C}(0.4^{\circ}\text{F})$
Power supply 電源供應 / 3*AAA battery
Measuring distance 測量距離 / 3-15cm
Weight 重量 / 90.5g



Blood Pressure & Oxygen Detection

血壓/血氧測試儀

Clip Finger Pulse Oximeter

夾指式脈搏血氧儀

FAN



一鍵操作



血氧測量



心率測量



- Blood oxygen, heart rate and pulse test
血氧、心率脈搏測試
- Small and light one button measurement, simple operation, more worry free use
小巧輕便 一鍵測量, 操作簡單, 使用更省心
- Silicone finger mold, soft and comfortable, no pressure on finger tips
矽膠指模, 柔軟舒適, 不壓迫手指末梢

- Product material 產品材質 / ABS, TFT LCD display
ABS, TFT 液晶屏顯示
- Power supply 電源供應 / 2*AAA battery
- Measuring Range 測量範圍 /
血氧濃度 (SPO2) 脈搏 (PR) 血流灌注指數 (PI)
- Weight 重量 / 27g

FAO



一鍵操作



血氧測量



心率測量



- Blood oxygen, heart rate and pulse test
血氧、心率脈搏測試
- Silicone finger mold, soft and comfortable, no pressure on finger tips
矽膠指模, 柔軟舒適, 不壓迫手指末梢

- Product material 產品材質 / ABS, TFT LCD display
ABS, TFT 液晶屏顯示
- Power supply 電源供應 / 2*AAA battery
- Measuring Range 測量範圍 /
血氧濃度 (SPO2) 脈搏 (PR) 血流灌注指數 (PI)
- Weight 重量 / 35.5g

Children's Version - Finger Clipper Oximeter

兒童款-夾指式血氧儀

FAV



一鍵操作



血氧測量



心率測量



- Blood oxygen, heart rate and pulse test, one click measurement
血氧、心率脈搏測試, 一鍵測量
- Specially designed for children: fit children's fingers, soft silicone finger pad
專為兒童設計: 貼合兒童手指, 柔軟矽膠指墊
- Suitable for children aged 3-14 with finger diameter of 8-25.4mm
適用於手指直徑8~25.4mm的3-14週歲兒童

- Product material 產品材質 / ABS, TFT LCD display
ABS, TFT 液晶屏顯示
- Power supply 電源供應 / USB charging/200mAh
- Measuring Range 測量範圍 /
血氧濃度 (SPO2) 脈搏 (PR) 血流灌注指數 (PI)
- Weight 重量 / 35g

Finger Type Oximeter With Bluetooth

夾指式血氧儀-帶藍牙

FAZ



一鍵操作



血氧測量



藍牙監測



- Blood oxygen, heart rate and pulse test
血氧、心率脈搏測試
- Bluetooth connection, APP displays the tester's health status in real time
藍牙連結, APP實時顯示測試者健康狀況

- Product material 產品材質 / PVC, TFT LCD display
PVC, TFT 液晶屏顯示
- Power supply 電源供應 / 2*AAA battery
- Measuring Range 測量範圍 /
血氧濃度 (SPO2) 脈搏 (PR) 血流灌注指數 (PI)
- Weight 重量 / 43g

Fingertip Test Oximeter With Bluetooth App

藍牙帶APP指尖測試血氧儀



- Product material 產品材質 / ABS, TFT LCD display
ABS, TFT液晶屏顯示
- Power supply 電源供應 / 2*AAA battery
- Measuring Range 測量範圍 /
- 血氧濃度 (SpO2) 脈搏 (PR) 血流灌注指數 (PI)
- Weight 重量 / 43g



Home Wrist Electronic Sphygmomanometer

家用腕式電子血壓計



- Product Material 產品材質 / ABS
- Power supply 電源供應 / 4*AAA battery
- Measuring Range 測量範圍 /
- 血壓 blood pressure: 0-37.3kPa (0-280)mmHg
- 心率 heart rate: (40 -- 195)beats / min
- Accuracy 準確度 /
- 血壓 blood pressure: ± 3 mmHg
- 脈動率值 pulsation rate value: $\pm 5\%$
- Weight 重量 / 134g



Automatic Arm Type Electronic Sphygmomanometer

全自動手臂式電子血壓計



語音播報 血壓測量 脈率測量



Arm type pressurization, one button automatic pressurization, simple to wear, easy to measure
手臂式加壓，一鍵自動加壓，簡單佩戴、輕鬆量測

Voice broadcast, high-definition screen display, convenient reading
語音播報，高清屏幕顯示，讀數方便



Monitor heart rate while measuring blood pressure
在測血壓的同時對心率進行監測

Store 99 pairs of memories to master health
儲存99組雙人記憶，掌握健康情況



- Product Material 產品材質 / ABS
Power supply 電源供應 / 4*AAA battery/USB
Measuring Range 測量範圍 /
血壓 blood pressure: 0-37.3kPa (0-280) mmHg
心率 heart rate: (40 -- 195) beats / min
Accuracy 準確度 /
血壓 blood pressure: ± 3 mmHg
脈動率值 pulsation rate value: $\pm 5\%$
Weight 重量 / 345g

Arm Type Electronic Sphygmomanometer

手臂式電子血壓計



血壓測量 脈率測量



Arm type pressurization, one button automatic pressurization, simple to wear, easy to measure
手臂式加壓，一鍵自動加壓，簡單佩戴、輕鬆量測

HD screen display, three color backlight, backlight color warning:
Green normal/Orange high/Red severe
高清屏幕顯示，三色背光，背光顏色警示：
綠色正常/橙色偏高/紅色嚴重



Monitor heart rate while measuring blood pressure
在測血壓的同時對心率進行監測

Data of two users can be recorded at the same time, and 90 groups of measurement results can be memorized for each user
可同時記錄兩位用家資料，每人90組量測結果記憶



- Product Material 產品材質 / ABS
Power supply 電源供應 / USB
Measuring Range 測量範圍 /
血壓 blood pressure: 0-37.3kPa (0-280) mmHg
心率 heart rate: (40 -200) beats / min
Accuracy 準確度 /
血壓 blood pressure: ± 3 mmHg
脈動率值 pulsation rate value: $\pm 5\%$
Weight 重量 / 313g

Arm Type Electronic Sphygmomanometer

臂式電子血壓測量儀



語音播報 血壓測量 脈率測量



Arm type pressurization, one button automatic pressurization, simple to wear, easy to measure
手臂式加壓, 一鍵自動加壓, 簡單佩戴、輕鬆量測

Voice broadcast, high-definition screen display, convenient reading
語音播報, 高清屏幕顯示, 讀數方便

Monitor heart rate while measuring blood pressure
在測血壓的同時對心率進行監測

Data of two users can be recorded at the same time, 2 * 192 groups of memory
可同時記錄兩位用家資料, 2*192組記憶



- Product Material 產品材質 / HDPE
Power supply 電源供應 / 4*AAA battery/USB
Measuring Range 測量範圍 /
血壓 blood pressure: 0-37.3kPa (0-280)mmHg
心率 heart rate: (40 -- 195)beats / min
Accuracy 準確度 /
血壓 blood pressure: ± 3 mmHg
脈動率值 pulsation rate value: $\pm 5\%$
Weight 重量 / 334g



Other Health Tests 其他测试

Blood Glucose Tester Set

血糖測試儀套裝

FJ



精準測量 大屏顯示



Micro blood sampling, blood glucose value is not affected by maltose, galactose, etc
微量採血, 血糖值不受麥芽糖、半乳糖等影響

Direct measurement, plug and play, reduce measurement error
直接測量, 即插即用, 減少測量誤差

180 groups of memory to master health
180組記憶, 掌握健康情況



1, insert the test strip



2, blood collection pen blood collection



3, test strip bloodsucking



4, waiting for the results



- Product Material 產品材質 / ABS,LCD
- Power supply 電源供應 / 2*AAA battery
- Measuring Range 測量範圍 / 1.1~33.3 mmol/l(20-600mg/dl)
- Measuring Time 測量時間 / 11±1S
- Weight 重量 / 555g

COVID-19 Rapid Virus Self Test Card

新冠病毒COVID-19 快速病毒自我檢測卡

FAU



精準測量 CE認證



Collect through nasal cavity to detect whether it is infected with the antigen of new coronavirus
通過鼻腔採集, 可以判斷是否染上新冠病毒的抗原

When the accuracy reaches 96.5% or above, there is no need to queue to save time and avoid the risk of crowd infection

準確度達96.5%或以上免去排隊節省時間, 避免排隊群聚感染風險

15-20 min rapid screening
15-20分鐘快速篩檢

EU CE certification can be queried
歐盟CE認證可查詢



Negative



Positive



Invalid

Instructions 使用方法



01 Swab Nostrils
採集樣本



02 Stir into Buffer
混入測試液



03 Apply to Device
滴進測試棒



04 Read Results
讀取結果



Eating Improver Series

飲食改善系列

Anti-shifting And Anti-sprinkling Bowl

進食防移位防灑碗



Protective design to avoid food spillage during use
護擋設計, 避免使用時溢出食物

Food grade pp material, safe and assured
食品級pp材料, 安全放心

The bottom of the silicone suction cup with soft bottom is pressed and emptied to adsorb on the smooth desktop, so that the bowl is fixed on the desktop and is not easy to slide
軟底矽膠吸盤碗底, 按壓排空 吸附在平滑桌面, 使碗固定在桌面不易滑動

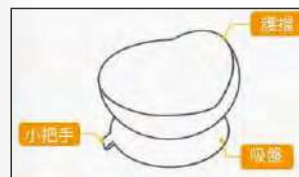

- Product Material 產品材質 /
Food grade PP + Non-toxic grade silicone
食用級PP塑膠+無毒級矽膠
Weight 重量 / 75g
- Applicable to: the elderly, patients, children, etc. who cannot carry bowls
適用於: 無法端碗的老年及病人, 兒童等

Stainless Steel Spoon

不銹鋼助食勺子



可彎曲 安全材質

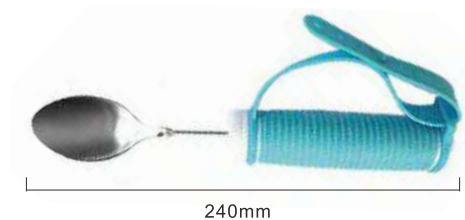

- Infrared sensor, high precision, supporting outdoor measurement
勺頭304不鏽鋼, 可調節角度
- Applicable to: the elderly, children or people with hand injuries
適用於: 老人、兒童或手部受傷人士

- Product Material 產品材質 / 304 stainless steel, food grade silicone
304不銹鋼, 食用級矽膠
- Size 尺寸 / 240*50*33mm
- Weight 重量 / 102g



360°旋轉 安全材質

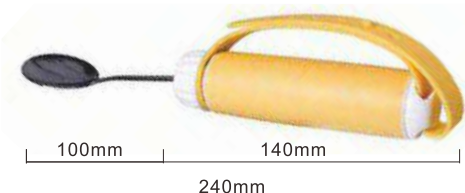

- Scoop head 304 stainless steel, 360° rotation adjustable
勺頭304不鏽鋼, 360°旋轉可調節
- Applicable to: the elderly, children or people with hand injuries
適用於: 老人、兒童或手部受傷人士

- Product Material 產品材質 / 304 stainless steel, food grade silicone, ABS
304不銹鋼, 食用級矽膠, ABS
- Size 尺寸 / 260*55*35mm
- Weight 重量 / 84g

Stainless Steel Fork

不銹鋼助食叉子



可彎曲 安全材質

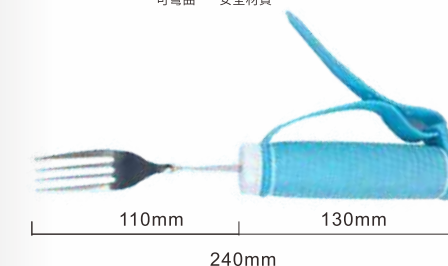

- Infrared sensor, high precision, supporting outdoor measurement
頭部304不鏽鋼, 可調節角度
- Applicable to: the elderly, children or people with hand injuries
適用於: 老人、兒童或手部受傷人士

- Product Material 產品材質 / 304 stainless steel, food grade silicone
304不銹鋼, 食用級矽膠
- Size 尺寸 / 240*50*33mm
- Weight 重量 / 103g



360°旋轉 安全材質

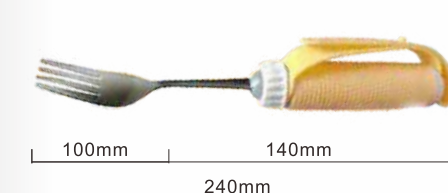

- Scoop head 304 stainless steel, 360° rotation adjustable
叉頭304不鏽鋼, 360°旋轉可調節
- Applicable to: the elderly, children or people with hand injuries
適用於: 老人、兒童或手部受傷人士

- Product Material 產品材質 / 304 stainless steel, food grade silicone, ABS
304不銹鋼, 食用級矽膠, ABS
- Size 尺寸 / 260*55*35mm
- Weight 重量 / 78g

Self-elastic Anti-slip Chopsticks

自彈式防滑夾菜筷子

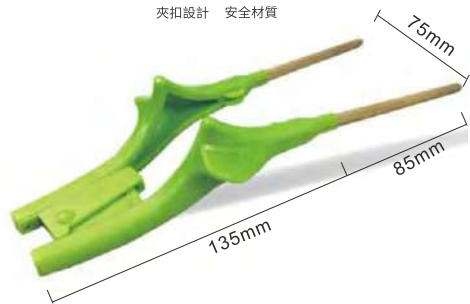

- The bolt design can automatically open the chopsticks and close them manually after food clamping
插銷設計, 可以自動打開筷子, 夾食後手力閉合
- Applicable to: the elderly, children or people with hand injuries
適用於: 老人、兒童或手部受傷人士

- Product Material 產品材質 / ABS+bamboo 塑膠+竹子
Size 尺寸 / 220*55*33mm
Weight 重量 / 50g

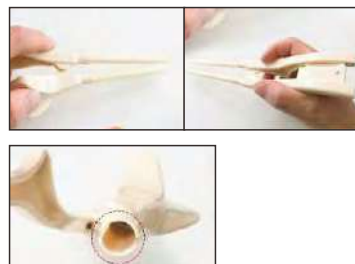

- The bolt design can automatically open the chopsticks and close them manually after food clamping
插銷設計, 可以自動打開筷子, 夾食後手力閉合
- Applicable to: Applicable crowd: the elderly, children and people with hand injuries
適用人群: 老人、兒童、手部受傷人士

- Product Material 產品材質 / ABS+bamboo 塑膠+竹子
Size 尺寸 / 220*55*33mm
Weight 重量 / 39g



Rehab Products Series For Limbs

康復產品系列-上下肢訓練

Electric Rehabilitation Training Fitness Machine With Remote Control

帶遙控電動康復訓練健身機



JCE 上肢&下肢 躺著運動 遙控控制



Upper limb movement: exercise arms, arms and wrists
Sitting/lying exercise: exercise leg joints and ankles

上肢運動:鍛煉胳膊手臂手腕
坐著/躺著運動:鍛煉腿部關節腳腕

Increase the stable anti slip bottom seat, touch screen, remote control

加大穩固防滑底坐, 觸控顯示屏, 遙控控制

Safety mode double guarantee: 30 minutes automatic stop, overload automatic stop
安全模式雙保證: 30分鐘自動停止, 超載自動停止

Applicable to: shoulder soreness, hand weakness, aging knees, inconvenient legs, hemiplegia

適用於: 肩部酸麻者, 手部乏力者, 膝蓋老化者, 腿腳不便者, 腿腳偏癱者康復訓練



- Product Material 產品材質 / ABS+electronic components
ABS+電子元件

Power supply 電源供應 / 220v

Control Method 控制方式 / manual/remote control
手動或遙控器調節阻力

Size 尺寸 / 220*55*33mm

Weight 重量 / 6800g

Electric Rehabilitation Training Fitness Machine

電動康復訓練健身機



JCD 上肢&下肢 躺著運動 按鍵遙控



Upper limb movement: exercise arms, arms and wrists
Sitting/lying exercise: exercise leg joints and ankles

上肢運動:鍛煉胳膊手臂手腕
坐著/躺著運動:鍛煉腿部關節腳腕

Anti slip bottom seat, key control, 12 speed adjustment
防滑底坐, 按鍵控制, 12檔速度調節

Switching between positive and negative modes will change the direction of movement and protect the patient's limbs during convulsion
正反轉模式切換, 痙攣時會改變運動方向, 保護患者肢體

Applicable to: shoulder soreness, hand weakness, aging knees, inconvenient legs, hemiplegia

適用於: 肩部酸麻者, 手部乏力者, 膝蓋老化者, 腿腳不便者, 腿腳偏癱者康復訓練



- Product Material 產品材質 / ABS+electronic components
ABS+電子元件

Power supply 電源供應 / 220v

Control Method 控制方式 / manual/remote control
手動或遙控器調節阻力

Size 尺寸 / 380*480*280mm

Weight 重量 / 4460g

Upper And Lower Limb Rehabilitation Training Bicycle

上下肢康復訓練腳踏車



上肢&下肢 摺疊設計 高度可調



Exercise upper and lower limbs
鍛鍊上肢和下肢

Folding design is adopted, pedal height is adjusted in three gears, and resistance is adjusted freely
採用折疊設計, 踏板高低三檔調節, 阻力大小自由調節

Four silicone suction cups on the base, thickened steel pipe, more stable and firm
底座四個矽膠吸盤, 加粗加厚鋼管, 更穩更牢

Applicable to: shoulder soreness, hand weakness, aging knees, inconvenient legs, hemiplegia
適用於: 肩部酸麻者, 手部乏力者, 膝蓋老化者, 腿腳不便者, 腿腳偏癱者康復訓練

● Product Material 產品材質 / metal pipe + engineering plastics
金屬管+工程塑膠

Control Method 控制方式 / manual free adjustment
手動自由調節

Size 尺寸 / 440*510*1050mm

Weight 重量 / 7000g



Physical Rehabilitation Training Fitness Equipment

肢體康復訓練健身器



上肢&下肢 阻力可調



Exercise upper or lower limbs
鍛鍊上肢或者下肢

Resistance adjustment: adjust the pedal resistance according to the individual
阻力調節: 根據個人調節腳踏機的阻力

Applicable to: upper and lower limb exercise, coordination exercises, fitness legs, rehabilitation physiotherapy, etc.

適用於: 上下肢運動、協調性練習、健身美腿、康復理療等

● Product Material 產品材質 / steel pipe 鋼管
Control Method 控制方式 / manually adjust resistance
手動調節阻力

Size 尺寸 / 500*410*280mm

Weight 重量 / 2300g

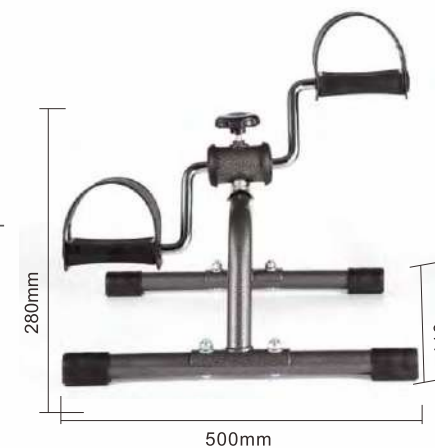

Electric Rehabilitation Bicycle With Remote Control

帶遙控電動康復訓練腳踏車



上肢&下肢 遙控控制 檔位可調



Exercise your lower limbs. You can also do lying exercises for early rehabilitation
鍛煉下肢，前期康復還可以躺著鍛煉

The remote control can touch the screen, mute the motor, operate in five gears, and switch different gears to meet different training needs

遙控可觸屏，靜音電機，五檔操控，切換不同的檔位，滿足不同訓練需求

Multiple ways of exercise, positive and negative intelligence, beneficial to muscle strength training
多種方式鍛煉，智能正反轉，有利於肌肉的力量鍛煉

Applicable to: rehabilitation training for people with shoulder soreness, hand weakness and inconvenient legs

適用於：肩部酸麻者，手部乏力者，腿腳不便者康復訓練



● Product Material 產品材質 /
ABS+electronics ABS+電子元件

Control Method 控制方式 /
wireless remote control /manual touch screen
無線遙控/手動觸屏

Size 尺寸 / 436*365*235mm

Weight 重量 / 6900g

Ankle Activity Rehabilitation Trainer

腳踝關節活動康復訓練器



腳踝鍛鍊 靜音/輕便



With Velcro strap, binding is not easy to slip
自帶魔术貼固定帶，綁定不易滑落

PVC striped anti-skid foot pad, which can sit on the ground without moving, and is safer

PVC條紋防滑腳墊，坐地不移動，更安全

Applicable to: rehabilitation patients of legs and ankles, fitness exercise crowd

用於：腿部、腳踝康復患者，健身鍛煉人群

材質：金屬+PP
產品尺寸：37*34*17cm
產品重量：2.38KG
包裝尺寸：40*35*19cm
包裝重量：3KG

● Product Material 產品材質 /
metal + PP+PVC 金屬 + PP+PVC

Training Mode 訓練方式 /
active training 主動訓練

Size 尺寸 / 370*340*170mm

Weight 重量 / 2380g



Elderly Electric Pedal Rehabilitation Training Machine

老年電動腳踏康復訓練機



Magnetic stone massage helps stimulate foot acupuncture points and promote blood circulation

磁石按摩, 有助於刺激足部穴位, 促進血液循環

30 gear speed adjustment, imitating walking, one button start

30檔速度調節, 模仿走路, 一鍵啟動

Passive training mode, imitating walking effect

被動訓練模式, 模仿走路效果



Applicable to: rehabilitation training for people with shoulder soreness, hand weakness and inconvenient legs
適用於: 肩部酸麻者, 手部乏力者, 腿腳不便者康復訓練

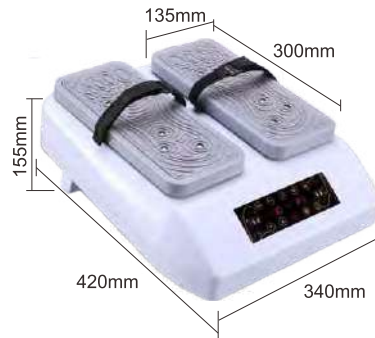

● Product Material 產品材質 /
ABS+electronics ABS+電子元件

Training Mode 訓練方式 /
passive training 被動訓練

Size 尺寸 / 420*340*155mm

Weight 重量 / 3780g



Rehab Products Series For Hand

康復產品系列-手部訓練

Spring Finger Muscle Strength Rehabilitation Training Device

彈簧手指肌力康復訓練器



360mm



- Aluminum alloy bracket, alloy spring, solid and durable, with strength and toughness
鋁合金支架, 合金彈簧, 結實耐用, 有強度有韌性

- Applicable to: finger and wrist dynamic training, finger and wrist strength function and strength training
適用於: 指、腕動態訓練, 手指及腕力功能和力量鍛煉

- Product Material 產品材質 / aluminum alloy frame + alloy spring leather finger cover + sponge pad
鋁合金框架+合金彈簧 皮革指套+海綿墊

Size 尺寸 / 230*360*200mm

Weight 重量 / 210g

Finger Grasping Trainer

手指抓握訓練器

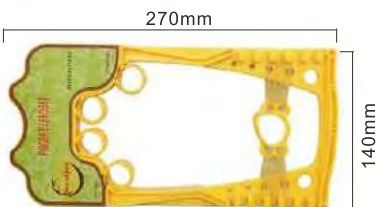

270mm

140mm



- The number of latex rings can be increased or decreased freely, and the force can be adjusted freely
乳膠圈數量自由增減, 自由調節力度

- Applicable to: hand training, postoperative rehabilitation, muscle strength training, etc
適用於: 手部訓練、術後康復、肌力鍛煉等

- Product Material 產品材質 / ABS+latex ring ABS+乳膠圈

Size 尺寸 / 270*140*15mm

Weight 重量 / 150g

Rehabilitation Training R-shaped Grip

康復訓練R形握力器



90mm

155 mm

- The strength is 5-40KG adjustable to enhance the muscle strength of the arm
力度5-40KG可調, 增強手臂肌力

- Applicable to: hand exercise training, postoperative rehabilitation, muscle strength training, etc
適用於: 手部運動訓練、術後康復、肌力鍛煉等

- Product Material 產品材質 / Spring steel+ABS+TPE 彈簧鋼+ABS+TPE

Size 尺寸 / 90*155*2mm

Weight 重量 / 125g

Children's Finger Strength Trainer

兒童指力訓練器



65mm

90mm



- Exercise children's finger strength, speed and coordination
鍛鍊兒童手指力度、速度、協調性

- Applicable to: piano and other musical instrument fingers, postoperative rehabilitation, muscle strength exercise, etc
適用於: 鋼琴等樂器手指, 術後康復、肌力鍛煉等

- Product Material 產品材質 / ABS+latex ring ABS+乳膠圈

Size 尺寸 / 90*65*20mm

Weight 重量 / 64g

Rehabilitation Grip Ring For Adults

成人康復握力圈

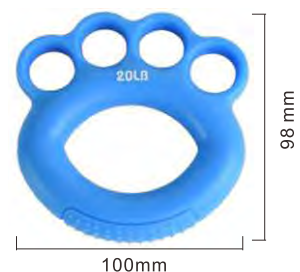

- Aluminum alloy bracket, alloy spring, solid and durable, with strength and toughness
分指設計四指環套防脫落

- Applicable to: hand strength training, rehabilitation training
適用於: 手部力量鍛煉, 康復訓練

- Product material 產品材質 / silicone 矽膠
Specifications 規格 / 10LB,20LB,30LB,40LB,50LB

Size 尺寸 / 98*100*15mm

Weight 重量 / 89g/90.5g/91.8g/93.7g/96.1g

Rehabilitation Grip Ring For Children

兒童康復握力圈



- Aluminum alloy bracket, alloy spring, solid and durable, with strength and toughness
分指設計四指環套防脫落

- Applicable to: hand function training for children, grip strength training for those with low hand strength
適用於: 兒童手功能訓練, 手部力量小者握力訓練使用

- Product material 產品材質 / silicone 矽膠
Specifications 規格 / 5LB,15LB,250LB,35LB

Size 尺寸 / 81*81*15mm

Weight 重量 / 55.2g/56.5g/58.1g/59.8g

Grip Ball For Finger Rehabilitation

分指康復握力球

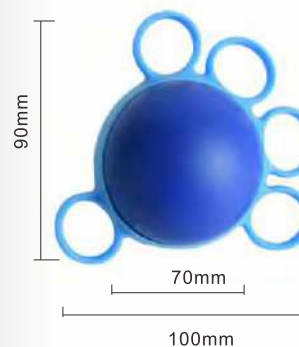

- Small strength, soft feel, split finger design is convenient for users to grasp
力度小、手感軟, 分指設計方便使用者抓握

- Applicable to: rehabilitation training of finger strength and grip strength for people with small hand strength
適用於: 手部力量小的人指力、握力康復訓練使用

- Product material 產品材質 / spherical elastic pu with silicone rubber
球體彈性pu, 球帶矽膠

Size 尺寸 / ball diameter 70mm, total 100mm
球直徑70mm, 共100mm

Weight 重量 / 54g

Silicone Finger Grip Ball

矽膠分指握力球

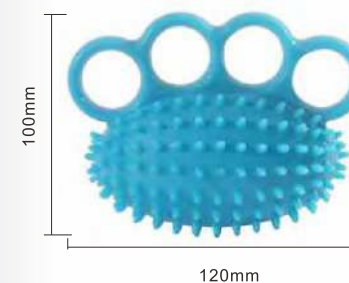

- Body bump massage tentacles, hollow air pressure, massage points
全身凸點按摩觸角, 空心氣壓, 按摩穴

- Applicable to: rehabilitation training of finger strength and grip strength for people with small hand strength
適用於: 手部力量小的人指力、握力康復訓練使用

- Product material 產品材質 / TPR+silicone TPR+矽膠
Strength 力度 / 10 LB

Size 尺寸 / 120*100mm

Weight 重量 / 70g



Sports Protective Gear For Hand

手部運動防護

Pressure Bandage Around Wrist

手腕纏繞加壓繃帶

RH



彈性耐用



調節加壓



- High elastic bandage can be wound without restriction, and high viscosity velcro can adjust the pressure
高彈繃帶纏繞不勒手,高粘魔術貼調節加壓

- Applicable to: running, fitness, playing ball and other sports
適用於:跑步、健身、打球等各種運動使用

- Product material 產品材質 / polyester fiber, spandex 聚酯纖維,氨綸

Size 尺寸 / before /after stretching
370*8mm / 500*8mm
拉伸前:370*8mm 拉伸後:500*8mm

Weight 重量 / 110g

Children's Wrist Sleeve Sheath

兒童手腕套護套

RA



彈性耐用



親膚透氣



- Good elasticity, comfortable to wear, close to skin, not easy to fall off
彈力良好穿戴舒適,貼合親膚不易脫落

- Applicable to: running, playing golf, cycling and other sports
適用於:跑步、打球、騎行等運動

- Product material 產品材質 / nylon, latex silk, spandex 尼龍,乳膠絲,氨綸

Color 顏色 / blue, pink 藍色, 粉色

Size 尺寸 / 90*70mm

Weight 重量 / 56g

Men's Sports Gloves

男士運動健身手套



- Wave point protection, new palm friction, grip strength to protect the palm
波點防護,新增手掌摩擦力、抓握力保護手掌
- Applicable to: cycling, fitness and outdoor sports
適用於: 騎行、健身、戶外運動

- Product material 產品材質 /
Nylon, spandex, lycra, polyurethane, polyester
錦綸, 氨綸, 萊卡, 聚氨酯, 聚酯纖維

Size 尺寸 / palm circumference 掌圍
S 170-190mm/M 190-210mm/L 210-230mm
Weight 重量 / 55g

Silicone Half-Finger Glove

戶外運動矽膠防滑半指手套



- Full palm silicone material, anti-skid and wear-resistant, increase friction, ice silk fabric on the back of the hand, comfortable and breathable
全掌矽膠材質, 防滑耐磨, 加大摩擦力, 手背冰絲面料, 舒適透氣
- Applicable to: fishing, cycling and other sports
適用於: 垂釣, 騎行等各種運動

- Product material 產品材質 /
Ice silk, silica gel, spandex 冰絲, 矽膠, 氨綸
Color 顏色 / pink, grey 粉色, 灰色
Size 尺寸 / applicable palm width 適用掌寬
S 90mm / M 95mm
Weight 重量 / 58g

Fitness Half Finger Gloves

健身半指手套



- Honeycomb silicone anti-skid pad in the palm, which is anti-skid and wear-resistant, and increases the friction of the palm
手掌蜂窩矽膠防滑墊, 防滑耐磨, 增強手掌摩擦力
- Applicable to: running, fitness, playing ball and other sports
適用於: 跑步、健身、打球等各種運動使用

- Product material 產品材質 /
polyurethane, polyester fiber, silicone
聚氨酯, 聚酯纖維, 矽膠
Size 尺寸 / 180*130*50mm
palm width 掌寬 (76-95mm)
Weight 重量 / 84g

Children's Non-Slip Half-Finger Gloves

兒童運動防滑半指手套

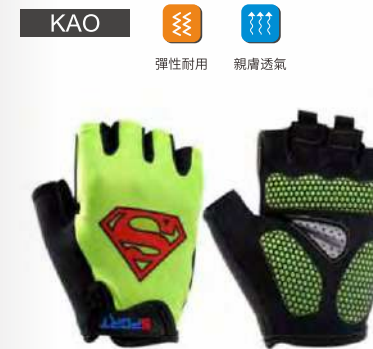

- Lycra fabric is comfortable and breathable, and the inner palm silicone rubber is anti-skid and shock absorbing
萊卡面料舒適透氣, 內掌矽膠防滑減震
- Applicable to: running, playing golf, cycling and other sports
適用於: 跑步、打球、騎行等運動

- Product material 產品材質 /
microfiber, lycra, silicone 超纖, 萊卡, 矽膠
Size 尺寸 / 110*110*20mm
applicable palm width 適用掌寬 L 65mm
Weight 重量 / 40g

Men's Sports Elbow Protector

男士運動護肘關節保護套



- Elastic fabric, comfortable to wear and close to skin, not easy to fall off
彈性面料, 穿戴舒適貼合親膚不易脫落

- Applicable to: cycling, fitness and outdoor sports
適用於: 騎行、健身、戶外運動

- Product material 產品材質 / nylon, latex silk, spandex 尼龍, 乳膠絲, 氨綸
Size 尺寸 / 250*210*20mm
Suitable for weight 適合體重
S 40-55 kg/M 55-77 kg/L 70-85 kg
Weight 重量 / 108g

Women's Sports Elbow Protection

女士運動護肘



- Elbow opening design to prevent hand clamping; Thickened sponge pad at joints for key protection
肘部開洞設計, 防止夾手; 關節處加厚海綿墊重點保護

- Applicable to: running, fitness, playing ball and other sports
適用於: 健身、打球等各種運動使用

- Product material 產品材質 / polyurethane, polyester fiber, silicone 聚氨酯, 聚酯纖維, 矽膠
Size 尺寸 / free size can be adjusted 均碼可調節
Weight 重量 / 157g

Women's Elbow Joint Protector

女式肘關節保護套



- Skin friendly fabric is comfortable and soft, with two-way compression and free adjustment without tension
親膚面料舒適柔軟, 雙向加壓自由調節不緊繃

- Applicable to: fishing, cycling and other sports
適用於: 跑步、健身等各種運動時使用

- Product material 產品材質 / OK cloth, SBR, nylon, spandex OK布, SBR, 錦綸, 氨綸
Size 尺寸 / free size can be adjusted 均碼可調節
Weight 重量 / 162g

Children's Sports Elbow Protector

兒童運動護肘



- Good elasticity, comfortable to wear, close to skin, not easy to fall off
彈力良好穿戴舒適, 貼合親膚不易脫落

- Applicable to: running, playing golf, cycling and other sports
適用於: 跑步、打球、騎行等運動

- Product material 產品材質 / nylon, latex silk, spandex 尼龍 乳膠絲 氨綸
Color 顏色 / blue, pink 藍色, 粉色
Size 尺寸 / 90*80*144mm
suitable for 8-12 years old 適合8-12歲
Weight 重量 / 80g



Sports Protective Gear For Lower Limb 下肢防護

Women's Thin Knee Protection

女士薄款運動護膝



- Knee shock absorption, stabilizing patella, cushioning and decompression; Bilateral memory springs, power assisted sports support
膝部減震,穩定髌骨,緩震減壓;雙側記憶彈簧,助力運動支撐

- Applicable to: running, fitness, playing ball and other sports
適用於:跑步、健身等各種運動使用

- Product material 產品材質 / nylon, spandex, elastic fiber
錦綸,氨綸,彈性纖維

Spec 規格 / M [knee circ 膝圍35.5-43cm/]

Suitable for weight 適合體重 55-70kg

Weight 重量 / 334g

Children's Sports Anti-collision Knee Pads

兒童運動防撞護膝



- Thickened rebound sponge, soft and durable cushion, no deformation
加厚回彈海綿,護墊柔軟耐用,不變形

- Applicable to: running, dancing and other children's sports
適用於:跑步、跳舞等兒童運動

- Product material 產品材質 / nylon sponge polyester fiber 尼龍 海綿 聚酯纖維

Size 尺寸 / 200*130*40mm

Suitable for children 適合兒童 45-80 kg

Weight 重量 / 92g

Anti Collision Sponge Knee Protector - Protector

防撞海綿護膝-運動減震護具



波浪防滑 舒適透氣 加厚防護



- Thickened sponge at the knee to prevent collision and fall; Wave anti slip strip to reduce sliding
膝部加厚海綿, 防撞防摔; 波浪防滑條, 減少下滑

- Applicable to: fitness and body building, cycling and other sports protection
適用於: 健身美體, 騎行運動等運動防護

- Product material 產品材質 / nylon EVA 尼龍 EVA
Size 尺寸 / M 210*150*60mm/L 230*160*60mm
leg circ 腿圍
M 30-40cm, L 41-50cm
Weight 重量 / 155g/165g

Women's Elbow Joint Protector

兒童運動膝蓋護套



彈性耐用 舒適透氣 加厚防護



- Skin friendly fabric is comfortable and soft; Thick rebound sponge pad, soft and durable
親膚面料舒適柔軟; 加厚回彈海綿護墊, 柔軟耐用

- Applicable to: running, dancing and other sports
適用於: 跑步、跳舞等兒童運動

- Product material 產品材質 / polyester cotton, latex silk, spandex, sponge
滌棉, 乳膠絲, 氨綸, 海綿
Color 顏色 / pink, black 粉色, 黑色
Size 尺寸 / S/M/L: 360/400/430 * 190mm
Weight 重量 / 162g

Sports Thigh Muscle Protector

運動大腿肌肉護具



波浪防滑 舒適透氣 雙向加壓



- Double wave silicone anti slip design, two-way compression and fixation with Velcro on both sides
雙波浪矽膠防滑設計, 兩側魔术貼雙向加壓固定

- Applicable to: running, fitness, playing ball and other sports
適用於: 跑步、健身等各種運動使用

- Product material 產品材質 / SBR, OK cloth, nylon, spandex
SBR, OK布, 錦綸, 氨綸

Spec 規格 / leg circ 腿圍 L 66cm, XL 75cm
Weight 重量 / 252g

Knee Joint Patellar Protective Fixation Bandage

膝關節膕骨保護固定繃帶



舒適透氣 雙向加壓



- Double thickened silicone glue, double shock absorption effect and stabilize the knee joint
雙重加厚矽膠, 減震效果加倍, 穩定膝關節

- Applicable to: running, dancing and other children's sports
適用於: 跳繩、跑步、騎行等運動

- Product material 產品材質 / OK cloth + silicone OK布+矽膠

Size 尺寸 / 570*60*30mm
leg circ 腿圍 35-45cm
Weight 重量 / 140g

Calf Protection Sports Compression Sleeve

護小腿運動壓縮套



波點防滑 舒適透氣 加厚防護



- High elastic fabric can keep warm under pressure, with strong wrapping
高彈面料加壓保暖, 包裹性強

- Applicable to: fitness and body building, cycling and other sports protection
適用於: 足球, 籃球, 羽毛球, 跑步等運動防護

- Product material 產品材質 / nylon, latex silk, spandex 尼龍, 乳膠絲, 氨綸

Size 尺寸 / 290*245mm
Upper leg circ 上腿圍: 29cm
lower leg circ 下腿圍: 24.5cm

Weight 重量 / 100g

Calf Protective Sports Sheath

護小腿運動護套



彈性耐用 舒適透氣 波浪防滑



- Skin friendly fabric is comfortable and soft; Double wave anti-skid silicone tape does not slide
親膚面料舒適柔軟; 雙波浪防滑矽膠條不下滑

- Applicable to: running, football, badminton and other sports
適用於: 跑步、足球、羽毛球等運動

- Product material 產品材質 / nylon+silicone 尼龍+矽膠

Size 尺寸 / 290*120*10mm

Weight 重量 / 98g

Thin Sports Ankle Support

薄款運動護踝



V型設計 舒適透氣 雙向加壓



- Ultra thin breathable fabric, comfortable and breathable; V-shaped strap design fits ankle structure

超薄透氣面料, 穿戴舒適透氣; V型綁帶設計, 貼合腳踝結構

- Applicable to: various sports, ankle injury and other protective effects
適用於: 各種運動, 腳踝受傷等保護作用

- Product material 產品材質 / sponge 海綿

Size 尺寸 / 200*150*20mm

Weight 重量 / 32g

Children's Sports Ankle Support

兒童專用運動護踝



彈性耐用 舒適透氣



- It is soft and comfortable to wear, and the elastic weaving is fine, uniform and firm
穿戴柔軟舒適, 彈力編織細密, 均勻牢固

- Applicable to: running, dancing and other children's sports
適用於: 跳繩、跑步、騎行等運動

- Product material 產品材質 / nylon, latex silk, spandex 尼龍 乳膠絲 氨綸

Size 尺寸 / 90*80*144mm
28-35 yards 28-35碼

Weight 重量 / 53g



Sports Protective Gear For others 其他防護

Sports Waist Belt

運動護腰收腹帶



彈簧支撐 舒適透氣 鋼板支撐



- The strap is pressurized to protect the waist; Gradient relieving pressure steel plate+10 springs
束帶加壓保護腰部; 梯度舒緩壓力鋼板+10根彈簧支撐

- Applicable to: running, squatting and other fitness activities
適用於: 跑步, 深蹲等健身運動

- Product material 產品材質 / nylon, SBR, polyester fiber, steel plate
尼龍, SBR, 聚酯纖維, 鋼板

Spec 規格 / M (waist 1'8 to 2'6)
L (Waist 2'7 to 3'2)
XL (Waist 3'3 to 3'9)

Weight 重量 / 385g

Children's Sports Waist Belt

兒童運動護腰收腹帶



彈性耐用 舒適透氣



- Surrounding protection, adjustable tightness, reduce waist injury due to improper force
環繞保護, 鬆緊程度可調節, 減少腰部因受力不當而受傷

- Applicable to: dance movement, protecting lumbar vertebrae
適用於: 舞蹈運動, 保護腰椎

- Product material 產品材質 / OK cloth Ok布

Size 尺寸 / free size (for 8-12 years old,
waist circo 1 feet 6-2 feet 3)
均碼(適用8-12歲, 腰圍1尺6-2尺3)

Weight 重量 / 85g

Men's Sports Shoulder And Arm Protection

男士運動護肩護臂

KM



舒適透氣 雙向加壓



- The shoulder is equipped with pressure protection block, double pressure, and multi angle fixation
肩部配備加壓防護塊，雙重加壓，多角度固定

- Applicable to: shoulder warmth and protection in various sports
適用於：多種運動中肩部保暖與防護等

- Product material 產品材質 /
OK cloth, T cloth, spandex OK布,T布,氨綸

Spec 規格 / arm circ 腿圍 up to 38cm

Weight 重量 / 120g

Fitness Anti Dislocation Protector

健身防脫臼護具

RL



彈性耐用 舒適透氣 雙向加壓



- Double compression of velcro elastic material at the shoulder peak to reduce joint burden
肩峰處魔術貼彈性材質雙重加壓，減輕關節負擔

- Suitable for shoulder protection in various sports
適用於多種運動中肩部防護

- Product material 產品材質 /
rubber, ok cloth, spandex 橡膠,ok布,氨綸

Spec 規格 / shoulder width around 90cm
肩寬90cm左右

Weight 重量 / 130g

Children's Sports 4-piece Set

兒童運動4件套護具

KQ



彈性耐用 舒適透氣 全方位呵護



- Knee guard/ankle guard/elbow guard/wrist guard four piece set, three-dimensional high elastic knitting, layer by layer protection
護膝/護踝/護手肘/護腕四件套，立體高彈編織，層層防護

- Applicable to: dancing, playing ball, running and other sports
適用於：跳舞、打球、跑步等各種體育運動

- Product material 產品材質 /
nylon, polyester fiber, spandex
尼龍,聚酯纖維,氨綸

Spec 規格 / M [Normal weight 8-12 years old]
M碼(適合8-12歲正常體重)

Weight 重量 / 216g

Children's Thick Sponge Sports Protective Set

兒童厚海綿運動護具套裝

KAA



彈性耐用 舒適透氣 全方位呵護



- New thickened sponge can protect and reduce injuries, and joint activities are free of restraint
新型加厚海綿保護降低受傷，關節活動無束縛

- Applicable to: roller skating, dance, martial arts, ball games, etc
適用於：輪滑溜冰、舞蹈武術、球類運動等

- Product material 產品材質 /
sponge, nylon, spandex, latex wire
加厚海綿、尼龍、氨綸、乳膠絲

Spec 規格 / suitable age: 4-6 years old
suitable height: 100-125cm
適合身高: 100-125cm
護膝適合腿圍: 27-30cm

Weight 重量 / 630g



Cervical Vertebra Traction Device

頸椎牽引

C E R V I C A L V E R T E B R A T R A C T I O N D E V I C E



Adjustable Hot Compress Type Cervical Traction Device

可調節熱敷型頸椎牽引器

JCG



鎖頭設計
固定按扣



人體工學



可調節升降



熱敷理療



- Height adjustable: double side lifting knob adjustment
高度可調節：雙側升降旋鈕調



- Humanized lock neck design and fixed button
人性化鎖頸設計、固定按扣



- Hot compress therapy in the back
後部熱敷理療

- Weight: About 400g
Heating temperature: up to 60°C

- Indications: back pain, neck and shoulder pain, dizziness and headache, neck stiffness, muscle swelling, neck and shoulder disc protrusion, back column bending.

- 重量：約400g
加熱溫度：最高60度

- 適應症：頸椎問題引起的腰酸背痛、頸肩酸痛、頭暈頭痛、脖子僵硬、肌肉酸脹、頸肩盤突出、背柱彎曲。



Inflatable Cervical Traction Apparatus

充氣式頸椎牽引器

JCK



手動充氣



人體工學



可自由調節



支撐減壓



- The neck brace is designed with a 20 degree forward tilt to fix the neck to a good cervical spine physiological curvature
頸託前傾20度設計,更符合頸椎生理曲度



- Manual inflation and longitudinal expansion of air can effectively traction the cervical spine
採用手動充氣,空氣縱向膨脹可有效牽引頸椎



- The neck cushion is removable for easy cleaning
頸部靠墊可拆卸方便清洗

- Material: PU+cotton
Weight: 410g Accessories: pump
Circumference: 69~76cm

- Suitable for: general cervical diseases, rehabilitation of cervical muscle sprain, correction of torticollis and bad posture.

- 材質: 硬性多孔聚丙烯+邊緣填充
重量: 410g 配件: 打氣筒
頸圍調節: 69-76cm

- 適用於: 一般的頸椎疾病, 頸部肌肉扭傷的康復, 亦可用於斜頸, 不良姿勢的矯正。



Hot Compress Type Cervical Traction Device

熱敷型頸椎牽引器

JCL



支撐減壓



人體工學



自由調節



熱敷理療



- The three in one surround design secures the neck to the best physiological curvature of the cervical spine
三合一的環繞式設計, 將頸部固定到最佳頸椎生理曲度



- Adjustable height and tightness
高低鬆緊可調節



- The back can be connected to electric hot compress physiotherapy
後部可以接電熱敷理療



- Material: PP+PC Height: 23~27cm
Weight: 310g Circumference: 48~68cm
Storage size: 23*16*15cm

- Suitable for: general cervical diseases, rehabilitation of cervical muscle sprain, correction of torticollis and bad posture.

- 材質: PP+PC 高度調節: 23~27cm
重量: 310g 頸圍調節: 48~68cm
收納尺寸: 23*16*15cm

- 適用於: 一般的頸椎疾病, 頸部肌肉扭傷的康復, 亦可用於斜頸, 不良姿勢的矯正。



Adjustable Cervical Support Protector

可調式頸椎支撐護具

JAC



雙重固定



360°環繞



多孔透氣



支撐減壓



- Padded edges for breathability and comfort
邊緣採用填充設計, 透氣舒適



- The plastic splint enhances the support, and the two sides are porous and breathable
塑膠夾板增強支撐, 兩側多孔透氣, 不悶熱



- Velcro fixed, not easy to fall, easy to adjust
魔术貼固定, 不易掉落, 調節方便



- Material: PP+ edge filling
Weight: 85g

- Applicable to: neck, shoulder, back pain, muscle strain caused by long-term head lowering or incorrect posture, resulting in shoulder, neck and hand pain.

- 材質: 硬性多孔聚丙烯+邊緣填充
重量: 85g

- 適用於: 長時間低頭或姿勢不正確導致頸肩背痛、肌肉勞損, 引起肩、頸及手的痛症。



Soft Cervical Spine Strengthened Support

軟式頸椎強化支撐護具

JR



支撐減壓



360°環繞



多孔透氣



可拆卸水洗



- Built-in plastic sheet to provide stable support
內置塑膠片, 提供穩定的支撐



- The adhesive button design makes it easy to wear.
The coat is made of cotton, soft and sweat absorbing.
It can be removed and washed

粘扣式設計, 穿戴方便, 外套全棉材質柔軟、吸汗, 可拆下來水洗

- Material: 100% cotton, 100% PU filling
Weight: 102g

- Suitable for cervical spondylosis, rehabilitation of various cervical spine injuries and neck muscle sprains, and also for torticollis and correction of bad postures.

- 材質: 100%棉, 100%PU填充物
重量: 102g

- 適用於: 頸椎病, 對各種頸椎損傷, 頸部肌肉扭傷的康復, 亦可用於斜頸, 不良姿勢的矯正。

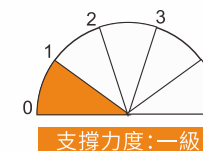

圍領型號	頸圍 cm	圍領-低cm	圍領-高cm
S 小號	25-36	7.5	8.5
M 中號	33-45	7.5	8.5
L 大號	36-48	7.5	8.5
XL 加大號	40-54	7.5	8.5



Height Adjustable Cervical Traction

高度可調式頸托

JT



支撐托護



360°環繞



人體工學



高度可調



頸圍



圍領高度

圍領型號	頸圍 cm	圍領高度 cm
L 大號	46-60	15

- Press and rotate the yellow button to adjust the height of neck bracket
按壓並旋轉黃色按鈕可調節頸托高度



- Adjust the Velcro to adjust the neck support tightness
調節勾毛扣粘合長度可調節頸托鬆緊



- It does not affect CT and MRI
不影響CT、磁共振檢查

- Material: PP+PC+100% cotton
Weight: 200g

- 材質: PP+PC+100%棉
重量: 200g

- Restrict neck movement, assist physical therapy and rehabilitation;
Rigid fixation to prevent cervical rotation and flexion after cervical spine surgery;
Neck syndrome with neck, shoulder and back pain.

- 限制頸部的活動，輔助物理治療及康復；
頸椎術後防止頸部旋轉、屈曲硬性固定；
頸、肩、背麻痛之頸部併發症。



Adjustable Cervical Spine Fixed Traction

可調節頸椎固定牽引

JBD



全立體支撐



360°環繞



人體工學



高度可調



- Height adjustable: double side lifting knob adjustment
六檔高低可調，適合不同人群



- Humanized lock neck design and fixed button
人性化鎖頸設計、固定按扣



- Lined with softer foam cotton, no injury to the skin, close to the cervical spine to strengthen fixation
內襯較軟泡沫棉，不傷皮膚，緊貼頸椎加強固定



- Material: ABS+ foam cotton
Weight: 190g

- 材質: ABS+泡沫棉
重量: 190g

- Suitable for cervical fixation, cervical degenerative spondylitis, neck fracture or postoperative support.

- 適用於：頸椎固定、頸部退化性頸椎炎、頸部骨折或術後支撐。



Children's Four-in-one Fixed Cervical Collar

兒童頸椎固定支具

JBE



全立體支撐



360°環繞



人體工學



高度可調



- Four level adjustment, Velcro adjustment
四檔高低調節, 魔术貼圍度調節



- The front opening adopts a large V-shaped design, which is breathable and easy to monitor and inspect
前部開口採用大V型設計, 透氣且便於監測、檢查

- Metal-free design, no need to disassemble during X-ray, CT and other inspections
無金屬設計, X光、CT等檢查時無需拆卸

- Material: ABS+ foam cotton
specifications: Children
Weight: 90g

- Suitable for: cervical fixation, cervical spondylitis, cervical fracture or postoperative support in children.

- 材質: ABS+泡沫棉 規格: 兒童款
重量: 90g

- 適用於: 用於兒童頸椎固定、頸椎炎、頸部骨折或術後支撐。



Thoracic & Lumbar Traction Device

胸&腰椎牽引

T H O R A C I C & L U M B A R T R A C T I O N D E V I C E



Pneumatic Lumbar Tractor With Magnetite

帶磁石充氣腰椎牽引器

JCH



全立體支撐 360°環繞 網狀透氣 充氣氣柱



- Vertical traction is adopted to sustain traction for tens of hours
採用直立式牽引, 可持續牽引支撐數十小時

110cm/ 充氣後 115cm

13cm/ 充氣後 20cm



- Equipped with 2 magnets, it can do traction and magnetic therapy at the same time
配有2顆磁石, 做牽引的同時還可以磁療

- Metal-free design, no need to disassemble during X-ray, CT and other inspections
25條空氣膨脹柱, 牽引力度大

- Material: PU + Cotton
Weight: 354g Extension band: 25x11cm
Size: 110x13cm before inflation
115x20cm after inflation

- Suitable for: cervical fixation, cervical spondylitis, cervical fracture or postoperative support in children.

- 產品材質: PU+棉
尺寸: 110x13cm 充氣前/115x20cm 充氣後
淨重: 354g 延長帶: 25x11cm

- 適用人群: 腰椎間盤突出、腰肌勞損、坐骨神經痛、背部腹痛人群, 腰部、腹部寒冷疼痛患者。



Inflatable Lumbar Traction

充氣型腰椎牽引器

JCI



人體工學 全立體支撐 自由增壓 充氣氣柱



- Reverse C arc traction, upright traction, three-dimensional support for the lumbar spine

反C弧度牽引, 直立式牽引, 三維立體支撐腰椎

110cm/ 充氣後 115cm

21cm

寬12cm

長23cm

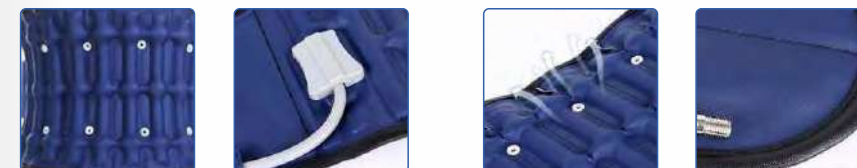

- H-type atmospheric column traction, self-inflation and pressurization
H型大氣柱牽引, 自行充氣加壓

- Deep airway ventilation is not stuffy and hot, lightweight PU material + vent design
深氣道通氣不悶熱, 輕便PU材質+透氣孔設計

- Material: PU + Cotton
Weight: 537g Extension band: 23x12cm

- Suitable for: patients with lumbar pain such as lumbar disc herniation, lumbar muscle strain, sciatica or postoperative support.

- 產品材質: PU+棉
淨重: 537g 延長帶: 23x12cm

- 適用於: 腰椎間盤突出、腰肌勞損、坐骨神經痛等腰部疼痛患者或術後支撐。



Widened Inflatable Hot Compress Lumbar Traction Device

加寬充氣熱敷腰椎牽引器

JCJ



雙重固定



全立體支撐



熱敷理療



充氣氣柱支撐



- Adopt vertical traction, after inflation, make the waist reach traction support
採用直立式牽引, 充氣之後, 使腰部達到牽引支撐

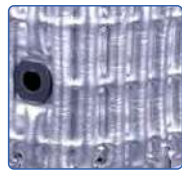

- Widened waist protection, H-shaped atmospheric column traction, breathable material
加寬護腰, H型大氣柱牽引, 透氣材質



- Double Velcro fixed, access to the power button can be hot compress
雙魔术貼固定, 接入電源一鍵即可熱敷



- Material: PU + Cotton
Weight: 480g
Extension band: 25.5x19.5cm

- Suitable for: Lumbar disc herniation, waist, abdominal cold pain and other adjuvant treatment, more suitable for the use of high body crowd.

- 產品材質: PU+棉
淨重: 480g
延長帶: 25.5x19.5cm

- 適用人群: 腰椎間盤突出, 腰部、腹部寒冷疼痛等輔助治療, 更適合身體較高的人群使用。



Men's Lumbar Fixed Protection Belt

男士腰椎固定護腰

KF



支撐減壓



自由增壓



彈力透氣



磁石點陣

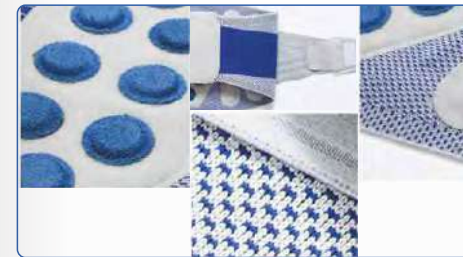

- Built in magnet: double compression, stable support, magnet dot matrix waist protection
內置磁石: 雙重加壓穩固支撐磁石點陣護腰



- Ergonomic design, more fit waist
人體工學設計, 更貼合腰圍



- Metal-free design, no need to disassemble during X-ray, CT and other inspections
三維針織科技, 軟硬有度, 彈性更強

- Material: three-dimensional knitted fabric
Weight: 480g
Suitable waist: 2 feet, 7-3 feet, adult

- Suitable for people: by exerting pressure on muscles to reduce the force on muscles during exercise, it is suitable for running, recovery, lumbar recovery, driving, etc.

- 產品材質: 三維針織面料
淨重: 480g
適合腰圍: 2尺7-3尺, 成人

- 適用人群: 通過對肌肉施加壓力, 減輕運動中肌肉所受的力, 適合跑步、收腹、腰椎恢復、開車等。



Breathable Abdominal Belt For Pregnant Women

孕婦專用托腹帶

JJ



托腹減壓



環繞支撐



彈力透氣



柔軟親膚



- Protect waist and abdomen, reduce abdominal pressure and relieve waist and abdomen fatigue
護腰托腹，讓孕婦減輕腹部壓力，緩解腰腹部疲勞



- Powerful Velcro can be adjusted for different stages of pregnancy
強力魔术贴可调整大小，適合孕期不同阶段



- Select high-quality gauze to be healthier, more skin friendly, breathable and soft
甄選優質紗布更加健康、更親膚，柔軟透氣

- Material: full stretch fabric
Weight: 166g
Abdominal Circumference: about 90cm

- Suitable for: pregnant women, abdominal surgeons and other abdominal support

- 產品材質:全彈力布料
淨重:166g
適用腹圍:約90cm左右

- 適用於:孕婦、腹部手術者等腹部支撐



Waist Protection Belt For Handling Work

加壓運動護腰固定器

JK



護腰固定



包裹支撐



舒適透氣



輕巧便攜



- Artificial curve design, strengthening fixation and double protection
人工學曲線設計，加強固定，雙重保護



- High viscosity Velcro, easy adjustment, fixed bandage, not easy to fall off
高粘魔术贴，輕鬆固定，鬆緊可調，穿戴方便



- Breathable fabric, soft and comfortable; It is not easy to deform and durable
透氣面料，親膚柔軟舒適；不易變形，持久耐用

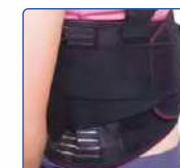

- Material: polyester fiber
Weight: M 356g, L 381g, XL 410g
Total waist length: 95cm, 98cm, 105cm

- Suitable for: labor protection such as handling, nursing recovery after lumbar surgery, lumbar muscle strain, back correction, etc

- 產品材質:聚酯纖維
淨重:M 356g, L 381g, XL 410g
腰圍總長度:95cm, 98cm, 105cm

- 適用於:勞動腰部保護，腰椎術後護理恢復、腰肌勞損、背部矯正等使用



Spinal Thoracic Postoperative Fixator

脊椎胸椎術後固定器

J1



安全防護



環繞支撐



彈力透氣



人體工學



- Artificial curve design, strengthen the fixation of lumbar spine and thoracic spine, and give double protection
人工學曲線設計, 加強腰椎、胸椎固定, 雙重保護



- Plate support, easy to wear and easy to use
板材支撐, 穿戴輕鬆, 使用方便



- Adjustable strong velcro, which can adjust the Tightness according to personal feelings
可調節強力魔术貼, 可根據個人感受調整鬆緊

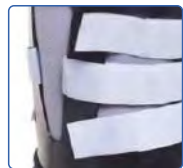
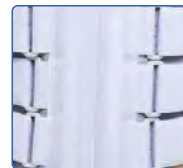

- Material: low temperature plastic plate
Weight: 510g
Waist circumference: 72-113cm

- Applicable: postoperative nursing recovery of spine and thoracic spine, rib compression and fixation, etc.

- 產品材質: 低溫可塑形板
淨重: 510g
適用腰圍: 72-113cm

- 適用於: 脊椎胸椎術後護理恢復, 肋骨壓縮固定等。



Chest Rehabilitation Fixed Protector

胸部康復固定護具

JBW



雙重固定



包裹支撐



舒適透氣



自由調節



- Elastic strap + breathable auxiliary strap, fixed up and down, triple lifting and compression, more stable
彈力背帶+透氣輔帶, 上下共同固定, 三重提拉加壓, 更加穩固



- High viscosity Velcro, easy adjustment, fixed bandage, not easy to fall off
高粘魔术貼, 輕鬆調節, 固定綁帶, 不易脫落

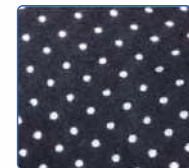

- Lightweight fabric, double-layer ventilation, elastic tension strap for comfort
輕盈面料雙層透氣, 彈性拉力綁帶, 穿戴舒適

- Material: polyester fiber
Weight: 215g
Waist circumference: 80-110cm

- Applicable: labor protection such as handling, nursing recovery after lumbar surgery, lumbar muscle strain, back correction, etc

- 產品材質: 聚酯纖維
淨重: 215g
適用腰圍: 80-110cm

- 適用於: 勞動腰部保護, 腰椎術後護理恢復、腰肌勞損、背部矯正等使用



Arm & Shoulder Traction Device

手臂&肩部支撐牽引

ARM & SHOULDER TRACTION DEVICE



Self Heating Shoulder Pad

自發熱肩部防寒熱敷護肩

JBA



熱敷保暖



貼合肩部



舒適透氣



點陣發熱

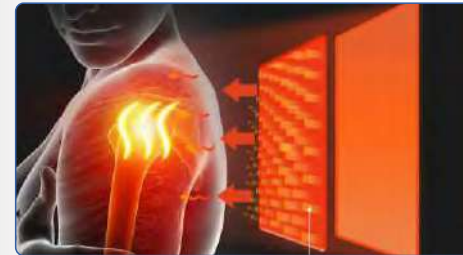

- Ritomaline self heating dot matrix covering in the shoulder, constant temperature heating and hot compress
肩內裡托瑪琳自發熱點陣覆蓋, 恒溫發熱熱敷

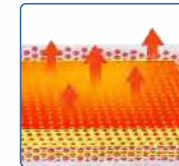

- Effectively relieve discomfort around the shoulder through far infrared light wave
通過遠紅外光波有效緩解肩周不適

- Acupoint maintenance to relieve shoulder pain: effectively relieve shoulder pain and discomfort
穴位養護緩解肩周酸痛: 有效緩解肩關節酸痛不適等問題

- Material: TC cotton
Weight: 147g

- Applicable: shoulder discomfort such as sour and soft around the shoulder and cold shoulder

- 產品材質: TC 棉
淨重: 147g

- 適用於: 肩周酸軟, 肩部發涼等肩部不適症



Forearm Sling

前臂吊帶

JAE



安全防護



雙重固定



彈力透氣



人體工學



- Ergonomic design, comfortable to wear, limiting arm movement back and forth
人體工程學設計, 穿戴舒適, 限制手臂前後移動

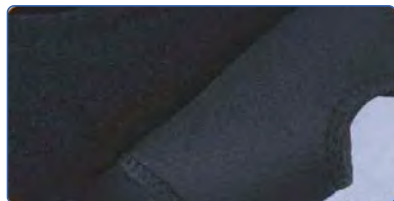

- Made of highly durable materials, soft and comfortable
高度耐用材料製成, 柔軟舒適



前臂長度 (cm)

吊帶型號	S小號	M中號	L大號
前臂長度 (cm)	29-34	35-39	40-42

- Material: 50% polyester, 40% polyurethane, 10% polyamide
Weight: 150g

- 產品材質: 50%聚脂纖維、40%聚氨酯、10%聚醯胺%
淨重: 150g

- Applicable:
Fixation after soft tissue injury of shoulder joint;
Radial and ulnar fractures were fixed;
Forearm suspension after elbow joint and forearm soft tissue injury;
Shoulder dislocation, post suspension, etc.

- 適用於: 肩袖損傷術後固定;
肩關節軟組織損傷後固定;
肘關節及前臂軟組織損傷後的前臂懸吊;
肩關節脫臼後懸吊等。



Shoulder Strap

肩部固定帶

JAF



安全防護



雙重固定



彈力透氣



人體工學

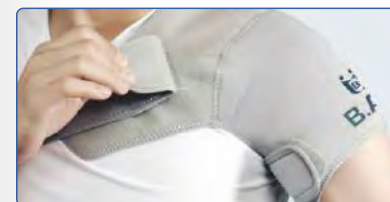

- Provide fixation and support of the shoulder and upper arm to assist the patient in gradually restoring motor ability
提供肩部和上臂的固定和支持協助病患部位逐漸恢復運動能力



- Perforated neoprene material, breathable and comfortable, can be worn on the surface of clothes
沖孔的NEOPRENE材料, 透氣舒適, 可以穿戴在衣服裏面

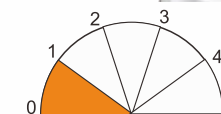

支撐力度: 一級

吊帶型號	S小號	M中號	L大號
肩寬 (cm)	34-41	40-46	45-52

- Material: perforated neoprene
Weight: 120g

- 產品材質: 沖孔氯丁橡膠
淨重: 120g

- Applicable:
Prevent shoulder strain, relieve shoulder pain, fix shoulder position and avoid excessive strain;
Assist in the treatment of shoulder sprain and contusion, relieve pain, accelerate rehabilitation and fixation after shoulder surgery.

- 適用於: 防止肩部拉傷, 舒緩肩部痛處, 固定肩部位置避免過份勞損;
輔助治療肩部扭挫傷、解除疼痛, 加速康復, 肩部手術後的固定。



Shoulder Joint Fixation Band

肩關節固定帶

JAG



固定支撐



自由調節



彈力透氣



人體工學



- The specially designed connection between the upper arm and forearm provides strong support and reduces the pull on the shoulder sleeve

上臂和前臂特殊設計的連接，提供強大的承托力，減輕對肩袖的拉扯，緩解肩部疼痛

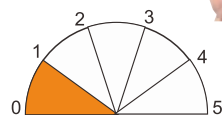
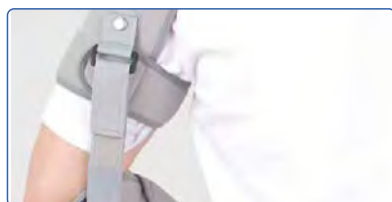

支撐力度：一級

吊帶型號	S小號	M中號	L大號
肩寬 (cm)	34-41	40-46	45-52

- The activity of forearm is not limited, and patients can carry out rehabilitation training
- 前臂的活動度不受限制，患者可以進行康復訓練

- Material: 70% polyester, 30% polyurethane
- Weight: 220g

- Applicable: Prevention and adjuvant treatment of shoulder subluxation caused by various reasons; Postoperative fixation of shoulder.

- 產品材質：70%聚脂纖維，30%聚氨酯
- 淨重：220g

- 適用於：預防和輔助治療各種原因導致的肩關節半脫位；肩部術後固定。



Multifunctional Arm Strap

多功能手臂固定帶

JD



前臂托護



360°環繞



親膚透氣



長短可調節



- Artificial curve design, strengthening fixation and double protection

自由調節，長短隨意，背部交叉設計，不易滑落，佩戴更方便



- High viscosity Velcro, easy to fix, elastic and adjustable, easy to wear
 - Breathable fabric, soft and comfortable; It is not easy to deform and durable
- 高粘魔術貼，輕鬆固定，鬆緊可調，穿戴方便
- 透氣面料，親膚柔軟舒適；不易變形，持久耐用

- Material: composite cloth
- Weight: 285g
- Single arm + bust: 114-119cm

- Applicable: shoulder clavicular fracture, scapular fracture, arm and upper arm fracture, used together with plaster after operation, instead of triangular towel after operation, can be used in stroke patients.

- 產品材質：複合布
- 淨重：285g
- 單臂+胸圍：114-119cm

- 適用於：肩部鎖骨骨折、骨胛骨折、手臂及上臂骨折、手術後及石膏一起使用、術後代替三角巾，可用於中風患者。



Arm Wrist Fracture Fixing Sling

手臂手腕骨折固定帶

JE



前臂托護



加強提拉



透氣面料



長度可調



- Double load-bearing, strengthen support and maintain a better fixed posture
雙重承重,加強支撐,保持更好的固定姿勢



- The length of the shoulder strap can be adjusted to a comfortable length according to the wearing situation
肩帶長度可調節,根據佩戴情況調到舒適的長度

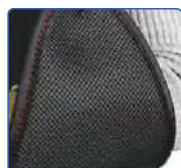

- Breathable skin friendly fabric, non slip, no displacement, comfortable shoulder pad, no neck injury
透氣親膚面料, 防滑不移位, 舒適肩墊不傷脖頸



- Material: lightweight composite fabric
Weight: 89g
Applicable arm size: 30cm

- Applicable:
Prevention and adjuvant treatment of shoulder subluxation caused by various reasons;
Postoperative fixation of shoulder.

- 產品材質: 輕薄複合面料
淨重: 89g
適用手臂尺寸: 30cm

- 適用於: 預防和輔助治療各種原因導致的肩關節半脫位; 肩部術後固定。



Elbow Joint Limit Fixed Tractor

肘關節限位固定牽引器

JV



前臂托護



轉盤設計



長短可調



人體工學



- Artificial curve design, strengthening fixation and double protection
轉盤設計, 金屬齒盤, 每10°可以設定伸展和屈曲角度, 旋轉自如如10~120°可調



- Adjust the screw position to adjust the length
調整螺絲位置, 可調節長短

型號	兒童碼	成人碼
肱骨外上髁至掌橫紋長度	29cm以下	29cm及以上

- Fabric: 50% polyester, 40% polyurethane, 10% polyamide
Bracket: 90% aluminum, 10% ABS
Weight: 450g Size: 530 * 130 * 10mm

- 適應症:
肘關節內骨折, 術後固定;
肘關節不穩定;
肘關節肌腱撕裂及韌帶損傷的治療與康復;
腦卒中後遺症肘關節的康復訓練, 糾正上肢屈肌痙攣模式。

- 面料: 50% 聚酯纖維, 40% 聚氨酯, 10% 聚醯胺
支架: 90% 鋁, 10% ABS
淨重: 450g
產品尺寸: 53*13*10cm



Children's Forearm Fracture Sling

兒童前臂骨折吊帶

JBB



前臂托護



加強提拉



透氣面料



長度可調



- Two straps at shoulder and waist
肩部和腰部兩根固定帶設計



- Built in removable cartilage support plate for auxiliary support
內置可拆卸軟骨托板, 輔助支撐



- Large mesh for comfort and breathability
大網眼舒適透氣



- Material: breathable mesh
Weight: S 180g, M 200g, L 215g
Applicable size: children aged 3-5, 5-8, 9-12
- 產品材質: 透氣網布
淨重: S 180g, M 200g, L 215g
適用尺寸: 兒童3-5歲, 6-8歲, 9-12歲

- Applicable:
The fixation of shoulder fracture dislocation or ligament injury is convenient to use and can be used instead of plaster.
- 適用於: 肩部的骨折脫位或韌帶損傷的固定, 使用方便, 可代替石膏使用。



Children's Sprained Shoulder Protector

兒童肩膀扭傷護具

JBC



前臂托護



充氣墊設計



長短可調



人體工學



- With armpit inflatable bag design, more effective arm support
附帶腋窩充氣袋設計, 更有效的支撐手臂



- Velcro design, freely adjustable
魔术貼設計, 金屬環扣, 可以自由調節



- Large mesh for comfort and breathability
大網眼舒適透氣



- Material: composite cloth
Weight: 150g

- 產品材質: 複合布
淨重: 150g

- Applicable:
fixation of shoulder fracture dislocation or ligament injury, easy to use.

- 適用於: 肩部的骨折脫位或韌帶損傷的固定, 使用方便。



Hand Fixing Supporter

手部固定支具

ARM & SHOULDER TRACTION DEVICE



Breathable Wrist Fixing Protective

透氣型手腕固定保護套

JAD



安全防護



雙重固定



舒適透氣



自由調節



- Artificial curve design, strengthening fixation and double protection
人工學曲線設計, 加強固定, 雙重保護

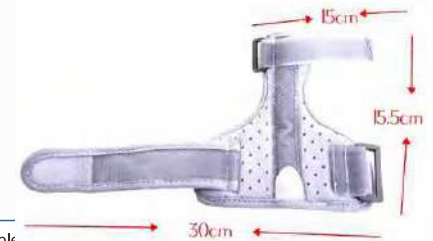

- Adjustable slide buckle with Velcro, adjustable elasticity, universal left and right
可調節滑扣配合魔术貼, 鬆緊可調, 左右通用



- Lightweight fabric for comfort and breathability
輕薄面料, 舒適透氣

- Material: composite cloth
Weight: 30g

- Applicable: mother's hand, thumb injury, keyboard hand, prevent and improve wrist damage and sports protection.

- 產品材質: 複合布
淨重: 30g

- 適用於: 媽媽手、拇指受傷、鍵盤手, 預防和改善手腕損傷及運動防護。



Thumb Wrist Fixed Protective Sleeve

拇指腕部固定保護套

JAO



魔術貼固定



加強提拉



透氣面料



長度可調



- Double fixation belt to promote hand rehabilitation
雙重固定帶, 促進手部康復



- Built in removable cartilage support plate for auxiliary support
高粘魔術貼, 鬆緊可調



- Large mesh for comfort and breathability
輕薄面料, 舒適透氣



- Material: breathable mesh
Weight: 64g

- Applicable: mother's hand, tenosynovitis, thumb injury, keyboard hand, etc.

- 產品材質: 複合布 鋁合金金屬條
淨重: 64g

- 適用於: 媽媽手、腱鞘炎、拇指受傷、鍵盤手等。



Finger Orthopedic Fixed Splint

手指矯形固定夾板

JAI



魔術貼固定



360°環繞固定



支撐保護



材質透氣



- Fit finger radian for effective fixation
貼合手指弧度, 有效固定



- High viscosity Velcro for easy fixation
高粘魔術貼, 輕鬆固定



- Light weight, breathable and comfortable cotton lining, which can be used repeatedly
重量輕, 透氣舒適純棉裏布, 可反覆使用



- Material: high density resin board + cotton
Weight: 8.8g
Size: 80*20mm

- Applicable: Finger correction, injured finger fixation and other needs, suitable for people aged 10 and above.

- 產品材質: 高密度樹脂板+棉
淨重: 8.8g
尺寸: 8*2cm

- 適用於: 手指矯正、受傷手指固定等需求。



Finger Joint Fixation Support

手指關節固定支撐

JAJ



魔術貼固定



加強提拉



透氣面料



長度可調



- Double fixation belt for different fingers
雙重固定帶, 不同手指適用



- Built in removable cartilage support plate for auxiliary support
高粘魔術貼, 鬆緊可調



- Lightweight material, comfortable and breathable, high strength
輕薄材質, 舒適透氣, 强度高



- Material: OK composite cloth + aluminum alloy steel plate
Weight: 12g
- Applicable: finger correction, fracture and sprain, postoperative fixation, etc.

- 產品材質: OK複合布+鋁合金鋼板
淨重: 12g
- 適用於: 手指矯正、骨折扭傷、術後固定等需求。



Double Finger Correction Fixed Splint

雙手指矯正固定夾板

JAK



魔術貼固定



環繞固定



合金板支撐



材質透氣



- Fit finger radian, effectively fixed, suitable for single / double finger use
貼合手指弧度, 有效固定, 適合單/雙手指使用



- High adhesive Velcro + aluminum alloy plate support
高粘魔術貼+鋁合金板材支撐



- Lightweight material, comfortable and breathable, high strength
輕薄材質, 舒適透氣, 强度高



- Material: high density resin board + cotton
Weight: 72g
- Applicable: finger correction, fracture and sprain, postoperative fixation, etc.

- 產品材質: 高密度樹脂板+棉
淨重: 72g
- 適用於: 手指矯正、骨折扭傷、術後固定等需求。



Injured Phalanx Fixator

受傷指骨固定器

JAM



魔術貼固定



環繞固定



透氣面料



合金板支撐



- Fit finger radian for effective fixation
貼合手指弧度, 有效固定



- High adhesive Velcro + aluminum alloy plate support
高粘魔術貼+鋁合金板材支撐



- Lightweight material, comfortable and breathable, high strength
輕薄材質, 舒適透氣, 强度高

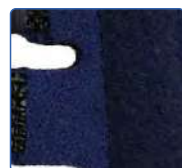

- Material: OK cloth, cotton cloth, flexible metal strip
Weight: 10g

- Applicable: finger correction, fracture and sprain, postoperative fixation, etc.

- 產品材質: OK布、棉布、可彎曲金屬條
淨重: 10g

- 適用於: 手指矯正、骨折扭傷、術後固定等需求。



Wrist Sprain Fixation Belt

腕關節手腕扭傷固定帶

JG



魔術貼固定



環繞固定



合金板支撐



材質透氣



- Strengthen the double fixation belt to promote hand rehabilitation
加固雙重固定帶, 促進手部康復

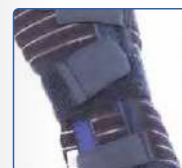

- High adhesive Velcro + built-in steel plate support
高粘魔術貼+內置鋼板支撐



- Elastic breathable fabric, comfortable and breathable, high strength
彈性透氣面料, 舒適透氣, 强度高



- Material: Composite cloth
Weight: 70g, 74g, 76g, 82g

- Applicable: hand and wrist injuries, hand rehabilitation, etc.

- 產品材質: 複合布
淨重: 70g, 74g, 76g, 82g

- 適用於: 手部手腕受傷、手部復健等手部康復使用。



Wrist Joint Fixed Support With Steel Plate

帶鋼板腕關節固定支撐

- JF



魔術貼固定
- 

加強提拉
- 

透氣面料
- 

開放環扣



- Fit wrist radian for effective fixation
貼合手腕弧度, 有效固定

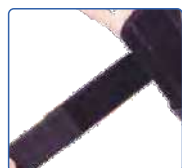

- Velcro design + open buckle, which can be adjusted freely
魔術貼設計+開放式環扣, 可以自由調節

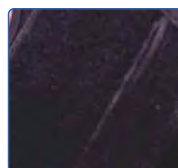

- Lightweight material, comfortable and breathable, high strength
輕薄材質, 舒適透氣, 强度高

- Material: composite cloth
Weight: 95g, 105g, 110g
Size: S 24*19cm/M 25* 22cm/ L 28*23cm

- Applicable: hand and wrist injuries, hand rehabilitation, etc.

- 產品材質: 複合布
淨重: 95g, 105g, 110g
產品尺寸: S 24*19cm/M 25* 22cm/ L 28*23cm

- 適用於: 手部手腕受傷、手部復健等手部康復使用。



Fixed Protector For Thumb Sprain

大拇指扭傷固定護具

- JH



魔術貼固定
- 

環繞固定
- 

鬆緊可調
- 

材質透氣



- Artificial curve design, strengthen fixation
人工學曲線設計, 加強固定



- High viscosity Velcro, easy to fix, elastic and adjustable
高粘魔術貼, 輕鬆固定, 鬆緊可調

- Elastic breathable fabric, comfortable and breathable, high strength
彈性透氣面料, 舒適透氣, 强度高

- Material: composite cloth
Weight: 30g, 32g, 36g

- Applicable: hand and wrist injuries, hand rehabilitation, etc.

- 產品材質: 複合布
淨重: 30g, 32g, 36g

- 適用於: 手部手腕受傷、手部復健等手部康復使用。



Children's Thumb Fixed Protective Sleeve

兒童大拇指固定保護套

KJ



魔術貼固定



環繞固定



透氣面料



合金板支撐



- Fit wrist radian for effective fixation
貼合手腕弧度, 有效固定



- High adhesive Velcro + aluminum alloy plate support
高粘魔術貼+鋁合金板材支撐



- Lightweight material, comfortable and breathable, high strength
輕薄材質, 舒適透氣, 强度高

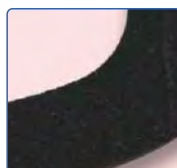

- Material: front OK cloth, back T cloth
Weight: 13g
Size: Wrist: 22cm finger: 9cm adjustable

- Applicable: hand and wrist injuries, hand rehabilitation, etc.

- 產品材質: 正面ok布, 反面T布
淨重: 13g
尺寸: 手腕: 22cm 手指: 9cm 可調節

- 適用於: 手部手腕受傷、手部復健等手部康復使用。



Finger Plate Finger Separator

手部分指板手指分離器

JL



魔術貼固定



環繞固定



分指固定



- Artificial curve design, strengthen fixation
人工學曲線設計, 加強固定



- High adhesive Velcro + aluminum alloy plate support
高粘魔術貼, 鬆緊可調



- Five fingers fixed separately
五指分開固定

- Material: plastic + composite cloth
Weight: 97g

- Applicable: finger separation, stroke, hemiplegia and other injuries were restored and fixed.

- 產品材質: 塑膠+複合布
淨重: 97g

- 適用於: 手指分離, 中風偏癱等受傷恢復固定。



Breathable Finger Injury Fixator

透气手指受傷固定器

JAM2



魔術貼固定



環繞固定



透氣面料



合金板支撐

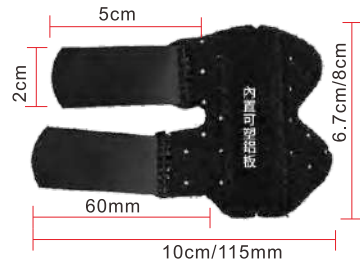

- Fit finger radian for effective fixation
貼合手指弧度, 有效固定



- High adhesive Velcro + aluminum alloy plate support
高粘魔術貼+鋁合金板材支撐



- Breathable fabric for comfort and breathability
透氣面料, 舒適透氣

- Material: OK cloth, cotton cloth, flexible metal strip
Weight: 7g, 10g

- Applicable: finger correction, fracture and sprain, postoperative fixation, etc.

- 產品材質: OK布、棉布、可彎曲金屬條
淨重: 7g, 10g

- 適用於: 手指矯正、骨折扭傷、術後固定等需求。



Adjustable Finger Injury Fixation Splint

可調節手指受傷固定夾板

JBQ



拉繩固定



環繞固定



柔軟內襯



支撐保護



- Fit wrist radian for effective fixation
貼合手腕弧度, 有效固定



- Pull rope fixation: the whole pull rope is fixed and can be adjusted according to its own situation
拉繩固定: 整根拉繩固定, 可根據自身的情況調節



- Soft rubber lining, soft without hurting hands
軟橡膠內襯, 柔軟不傷手

- Material: ABS + silicone
Weight: 13g

- Applicable: finger correction, fracture and sprain, postoperative fixation, etc.

- 產品材質: ABS+矽膠
淨重: 13g

- 適用於: 手指矯正、骨折扭傷、術後固定等需求。

Hand Training Deformity Straightener

手部訓練畸形壓直器

JBS



螺絲固定



柔軟內襯



壓力矯正



- Artificial curve design, strengthen fixation
人工學曲線設計, 加強固定



- The pressure intensity can be adjusted freely
壓力強度可自由調節



- Soft lining does not hurt hands
柔軟內襯不傷手



- Material: aluminum alloy + silicone adhesive
Weight: 36g
- Applicable: finger bending fixation, finger correction, finger training, etc.

- 產品材質: 鋁合金+矽膠
淨重: 36g
- 適用於: 手指彎曲固定、手指矯正、手指訓練等。



Lower Limb Traction Device

下肢牽引拉伸

T H O R A C I C & L U M B A R T R A C T I O N D E V I C E



Hip Orthosis Traction Device

髖關節矯形牽引器

- JX**
- 結構穩固
 - 轉盤設計
 - 長短可調
 - 人體工學



- It is applicable to the left and right sides. Adjust the chuck control and fixation
左右兩側適用，調整卡盤控制及固定

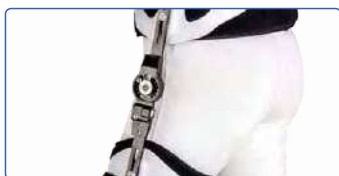

- The metal hub design structure is more robust
金屬樞紐設計，結構更加堅固

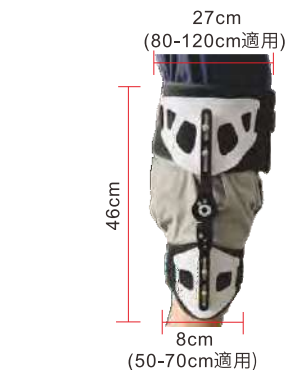

- Adjust the screw position to adjust the length
調整螺絲位置，可調節長短

- Material: polyurethane + abs + alloy
Weight: 830g

- 產品材質：聚氨酯+ABS+合金
淨重：830g

- Applicable: postoperative fixation of hip joint, fixation in case of hip fracture or dislocation, after hip arthroplasty, degenerative hip arthritis.

- 適用於：髖關節手術後固定，髖關節骨折或脫臼時固定，髖關節人工置換術後，退行性髖關節炎。



Far Infrared Kneepad

遠紅外護膝

- JY**
- 彈力支撐
 - 遠紅外設計
 - 透氣面料
 - 環保止滑點



- High elastic fiber weaving, breathable structure, not easy to slip
高彈纖維織造，結構透氣，不易滑脫



- Environmental protection slip stop point
環保止滑點

- Material: 40% polyamide, 30% polyester, 20% styrene butadiene rubber, 10% far infrared powder
Weight: 64g

- 產品材質：40%聚醯胺，30%聚酯，20%丁苯橡膠，10%遠紅外粉
淨重：64g

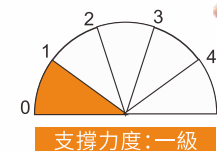

型號	S小號	M中號	L大號
膝蓋上8cm 周徑 (cm)	36-39	39-43	43-47

- Applicable: it provides mild warmth and support for the knee joint. It is suitable for acute and chronic pain of the knee joint, unstable joint or slight strain and sprain. Prevent knee joint injury in sports or athlete training with injury.

- 適用於：提供膝關節溫和的保暖與支撐，適用於膝關節急、慢性疼痛，關節不穩或輕微拉傷、扭傷。預防運動中膝關節的損傷或運動員帶傷訓練。



Open Knee Joint Fixator

開放式膝關節固定器

JZ



開放設計



透氣面料



穩固支撐



人體工學



- Perforated neoprene fabric for warmth and breathability
冲孔NEOPRENE面料, 保暖透氣

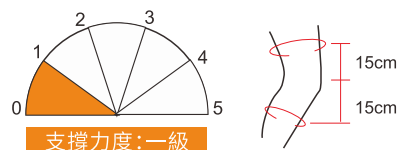

型號	S小號	M中號	L大號
膝蓋上 15cm處周徑 (cm)	39-49	47-53	53-60
膝蓋下 15cm處周徑 (cm)	27-35	33-38	36-40



- Bionic biaxial hinges on both sides protect ligaments and stabilize knee joints
兩側仿生雙軸鉸鏈, 保護韌帶, 穩定膝關節



- Open design, which can be worn by people with mobility difficulties
開放式設計, 行動不便者可自主穿戴

- Material: 50% polyamide, 40% styrene butadiene rubber, 10% polyester, 100% aluminum
Weight: 280g

- Applicable: acute mild to severe knee pain, hip instability, patellar subluxation and dislocation, lateral collateral ligament injury

- 產品材質: 50% 聚醯胺, 40% 丁苯橡膠, 10% 聚酯纖維, 100% 鋁
淨重: 280g

- 適用於: 急性輕度至重度膝部疼痛者, 髌骨不穩定, 膕骨半脫位及脫位, 側副韌帶損傷



Three Piece Knee Joint Fixator

三片式膝關節固定器

JAW



三片式設計



穩固支撐



多扣位固定



人體工學



- High strength aluminum alloy support strip, which can strongly fix the knee joint in the straight position
高強度鋁合金支撐條, 強力固定膝關節在伸直位



- Three piece design, suitable for people of different sizes
三片式設計, 適用於不同身材人群

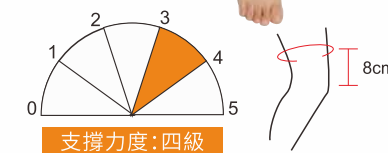

型號	S小號	M中號	L大號
膝蓋上 8cm處周徑 (cm)	36-39	39-43	43-47

- Material: 50% polyester, 40% polyurethane 10% polyamide, rod 100% aluminum
Weight: 645g

- Applicable: 1. Fixation before and after operation for tibial plateau fracture, distal femoral fracture, proximal fibular fracture, or knee ligament injury.
2. It can replace plaster or splint (it should be used under the guidance of a specialist).

- 產品材質: 50% 聚酯纖維, 40% 聚氨酯, 10% 聚醯胺, 支條 100% 鋁
淨重: 645g

- 適用於: 脛骨平臺骨折、股骨遠端骨折、腓骨近端骨折, 或膝關節各個韌帶損傷手術前後的固定。
可以代替石膏或夾板 (應在專科醫生指導下使用)。



Portable Knee Joint Limit Fixation Tractor

輕便膝關節限位固定牽引器

JAX



開口設計



轉盤設計



透氣面料



人體工學



- Turntable design, buckling angle can be set every ten degrees
轉盤設計，每十度可以設定屈曲角度

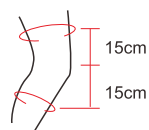

型號	S小號	L大號
膝蓋上 15cm處周徑 (cm)	39-49	53-60
膝蓋下 15cm處周徑 (cm)	27-35	36-40



- Opening design for easy wearing
開口設計，方便穿戴



- Breathable fabric, lightweight and not easy to slip off
透氣面料，輕便不易滑脫

- Material: 50% polyester, 40% polyurethane 10% polyamide, rod 100% aluminum
Weight: 430g

- Applicable:
Treat knee ligament strain and tear.
Fixation and rehabilitation exercise after knee surgery and arthroscopic surgery (should be used under the guidance of a specialist).

- 產品材質：50%聚酯纖維，40%聚氨酯 10%聚醯胺，支條100%鋁
淨重：430g

- 適用於：
治療膝關節韌帶拉傷，撕裂。
膝關節術後，關節鏡手術後的固定和康復鍛煉。（應在專科醫生指導下使用）



O-type Leg Orthosis

O型腿矯正器

JAZ



龍骨夾板固定



鋁板支撐



氣囊加壓



三帶合一



- Remote control automatic pressure, both sides built-in TPU stereo air bag pressure
遙控自動加壓，兩側內置TPU立體氣囊加壓



- Aluminum plate support fits the sides of the legs
鋁板支撐貼合腿部兩側



- Material: polyester, spandex
Weight: 958g



- Velcro fixed, three in one design, comprehensive coverage
魔术貼固定，三帶合一設計覆蓋全面



- 產品材質：聚酯纖維，氨綸
淨重：958g

- Applicable: leg shape is not correct, leg swelling, muscle stiffness, muscle tension, leg edema and other leg correction.

- 適用於：腿型不正，腿部發脹，肌肉僵化，肌肉緊張小腿水腫等腿部矯正。



Adjustable Leg Fixed Bracket

可調節腿部固定支架

JBU



環繞固定



轉盤設計



透氣面料



鋁條支撐



- Adjustable chuck, progressive recovery angle adjustment
可調節卡盤, 漸進式恢復角度調節

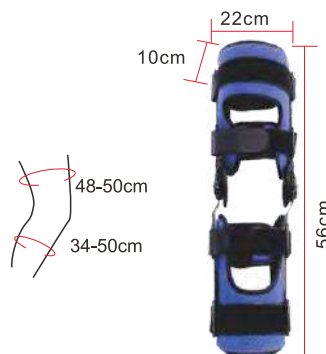

- Multiple anti slip straps + high viscosity Velcro
多條防滑綁帶+高粘魔術貼



- Aluminum strip support, breathable fabric
鋁條支撐, 透氣面料



- Material: aluminum alloy + sponge pad
Weight: 1050g

- Applicable: leg injury, knee injury, ligament strain, leg orthopedics, etc.

- 產品材質: 鋁合金+海綿墊
淨重: 1050g

- 適用於: 腿部受傷、膝蓋受傷、韌帶拉傷、腿部矯形等。



Adjustable Knee Brace

可調節膝關節支架

JBV



環繞固定



轉盤設計



透氣面料



鋁條支撐



- Adjustable chuck, progressive recovery angle adjustment
可調節卡盤, 漸進式恢復角度調節

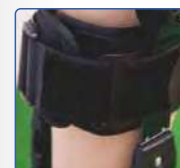

- Multiple anti slip straps + high viscosity Velcro
多條防滑綁帶+高粘魔術貼

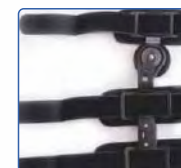

- Alloy support
合金支架支撐



- Material: aluminum alloy + composite cloth
Weight: 958g

- Applicable: knee injury and rehabilitation exercise.

- 產品材質: 鋁合金+複合布
淨重: 933g

- 適用於: 膝關節部位受傷和康復鍛煉。



Three Piece Knee Fixator With Strap

三片式背帶型膝關節固定支具

JBX



背帶設計



三片式設計



透氣面料



鋁條支撐



- Strap design, elastic tension strap
三片式設計, 背帶設計, 彈性拉力綁帶

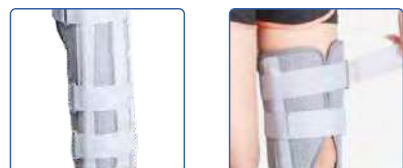

- High viscosity Velcro, fixed strap
高粘魔术贴, 固定綁帶



- Lightweight, breathable fabric with detailed edging
輕盈透氣面料, 細緻包邊

- Material: OK cloth + Velcro
Weight: 492g

- Applicable: leg injury, knee injury, ligament strain, leg orthopedics, etc.

- 產品材質: OK布+魔术贴
淨重: 492g

- 適用於: 腿部受傷、膝蓋受傷、韌帶拉傷、腿部矯形等。



Lower Limb Stretch Belt

下肢拉伸帶

JBK



多位提拉



魔术贴固定



一體化設計



- Multiple lifting points to freely control the lifting force
多個提拉點, 自由控制提拉力度



- Integrated design
用一體成型設計



- Velcro straps make it easier to wear
魔术贴綁帶, 穿戴更方便

- Material: comfortable composite fabric
Weight: 115g
Size: 26 * 13 * 2cm

- Applicable: lifting rehabilitation training of lower limb assistance.

- 產品材質: 舒適復合面料
淨重: 115g
尺寸: 26*13*2cm

- 適用於: 下肢助力的提拉康復訓練。



Foot Fixing Supporter

足部固定支具

ARM & SHOULDER TRACTION DEVICE



Adjustable Foot Rest

可調節足部防護托

JAH



拉繩設計



魔術貼固定



透氣面料



鋁條支撐



- Artificial curve design, strengthen fixation
人工學曲線設計，加強固定



- Fixed with Velcro, adjustable sliding buckle and aluminum strip support
魔術貼固定，可調節滑扣，鋁條支撐



- Lightweight fabric for comfort and breathability
網孔面料，舒適透氣

- Material: aluminum alloy strip, nylon strap, breathable OK cloth
Weight: 100g

- Applicable: plantar fasciitis stretching, dorsalis pedis sprain and postoperative recovery to prevent foot ptosis.

- 產品材質：鋁合金條、尼龍綁帶、透氣OK布
淨重：100g

- 適用於：腳底筋膜炎拉伸，足背拉傷扭傷及術後恢復，預防足下垂。



Inflatable Foot Protector

充氣型足部防護托

JAL



多位提拉



魔術貼固定



一體化設計



- Inflator, inner, bilateral air bags
充氣囊內裡, 雙側氣囊



- Thickened sponge lining, ankle splint
加厚海綿內裡, 足踝夾板

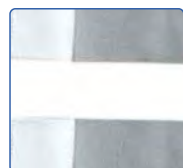

- Velcro fixing
魔術貼固定



- Material: aluminum alloy strip, nylon strap, breathable OK cloth
Weight: 239g
- Applicable: ankle sprain, foot correction, etc.

- 產品材質: 鋁合金條、尼龍綁帶、透氣ok布料
淨重: 239g
- 適用於: 踝關節扭傷、腳部矯正等。



Talipes Valgus Fixator

大拇指外翻固定器

JAN



魔術貼固定



透氣面料



鋁條支撐



- Side aluminum strip auxiliary support
側面鋁條輔助支撐



- Velcro fixing
魔術貼固定



- Breathable fabric
透氣面料



- Material: composite cloth + aluminum alloy strip
Weight: 72g
- Applicable: thumb and toe valgus, toe injury, etc.

- 產品材質: 複合布+鋁合金條
淨重: 72g
- 適用於: 大拇指腳趾外翻、腳趾受傷等需求。



Foot And Thumb Valgus Fixation Strap

腳拇指外翻固定帶

JU



三維支架



魔術貼固定



透氣面料



人體工學



- Three dimensional support, movable hinge
三維支架,活動鉸鏈

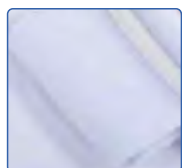

- OK fabric, soft filler
Ok布料, 填充物柔軟

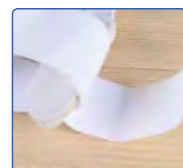

- Velcro fixing
魔術貼固定



- Material: composite fabric, PC support, metal buckle
Weight: 25g

- Applicable: correction of toe sprain, hallux valgus, overlapping toes and long-term wearing high heels are recommended.

- 產品材質: 複合面料, PC 支架, 金屬扣
淨重: 25g

- 適用於: 腳趾扭傷、拇趾外翻矯正, 腳趾重疊、長期穿著高跟鞋人士推薦使用。



Foot Drop Soft Foot Support

垂足軟足托

JAY



交叉扣帶



魔術貼固定



柔軟透氣面料



人體工學



- Artificial curve design, strengthen fixation
人工學曲線設計, 加強固定



- Adjust the length of cross buckle to fix
調節交叉扣帶長度固定



- The material is breathable and soft, and can be worn in shoes
材質透氣、柔軟, 可穿在鞋內

- Material: 14% nylon, 85% polyester, 100% polyurethane
Weight: 73g

- Applicable: Correct foot sagging caused by various reasons; Treat mild foot varus, foot valgus and plantar fasciitis.

- 產品材質: 14% 尼龍 85% 滌綸, 100% 聚氨酯
淨重: 73g

- 適用於: 矯正各種原因導致的足下垂; 治療輕度的足內翻、足外翻, 足底筋膜炎。



Ankle Sprain Fixed Protective Cover

踝關節扭傷固定保護套

- KD

X

交叉扣帶
- 魔術貼固定
- 柔軟透氣面料
- 仿生夾板



- Three dimensional support, movable hinge
人工學曲線仿生固定夾板

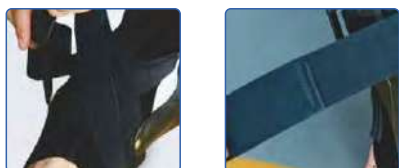

- OK fabric, soft filler
強力魔術貼粘貼, X交叉綁帶

	S小號	M中號	L大號
SIZE	35-38	39-42	43-48

- Material: composite fabric, PC support, metal buckle
Weight: 150g
- Applicable: running, fitness, playing ball and other sports and sprain, sports strain, postoperative recovery, etc.
- 產品材質: 複合面料, PC支架, 金屬扣
淨重: 150g
- 適用於: 跑步、健身、打球等各種運動與崙腳、運動拉傷、術後恢復等。



Ankle Fixed Foot Drop Brace

踝關節固定支具

- JBT

魔術貼拉帶
- 柔軟面料
- 鋼板支撐
- 金屬固定扣



- Plastic buckle, detachable design
塑膠搭扣, 可拆卸式設計



- Velcro strap design
魔術貼綁帶設計
- High density sponge is soft and comfortable
高密度海綿柔軟舒適

- Material: resin plastic board + sponge pad
Weight: 520g
- Applicable: foot recovery, foot drop, etc.
- 產品材質: 樹脂塑膠板+海綿墊
淨重: 520g
- 適用於: 足部恢復、足下垂等。



Intelligent Massager

智能按摩器

Intelligent Bluetooth Eye Protector

智能藍牙眼部按摩儀



- Air pressure massage+hot compress+vibration massage+music, wireless Bluetooth connection;3D air bag kneading, with temple kneading massage
氣壓按摩+熱敷+振動按摩+音樂, 無線藍牙連接; 3D氣囊揉捏, 附帶太陽穴揉壓按摩



- Three in one split structure, 180° folding, easy to carry out
三合一一體式結構, 完成180°折疊, 外出攜帶也方便

- Product material 產品材質 / PU leather + ABS shell PU皮+ABS外殼
Working time 工作時間 15 minutes / time
Size 尺寸 / 230*90*45mm
Weight 重量 / 385g

Children's Intelligent Eye Massage Instrument

兒童款智能眼部按摩儀



- 17 vibration motors, 5 massage modes, precise massage of acupoints, relieving eye fatigue
17個震動馬達, 5種按摩模式, 精準按摩穴位, 緩解眼睛疲勞



- Visualized lenses can be massaged when you open or close your eyes
可視化的鏡片, 睜眼閉眼都可以按摩

- Product material 產品材質 / ABS+PC
Working time 工作時間 / 15 minutes / time
Size 尺寸 / 156*58*43mm
Weight 重量 / 158g



Smart Massage Sleep Eye Mask

智能按摩睡眠眼罩



- Relieve fatigue with low-frequency pulse technology and 20 minute intelligent massage
舒緩低頻脈衝科技緩解疲勞,20分鐘智能按摩



- Eye mask is made of high-density sponge, which is soft and breathable
眼罩採用高密度海綿,柔軟度強高,且透氣



- Product material 產品材質 /
ABS plastic + polyester Lycra
ABS塑膠+滌綸萊卡
- Working time 工作時間 / 20 minutes
- Size 尺寸 / 235*92mm
- Weight 重量 / 54g

Shoulder And Neck Thump Massage Shawl

肩頸捶打按摩披肩



- One head tapping on the left and right of the shoulder, two massage modes, adjustable strength, automatic timing
肩部左右各一個敲頭,兩種按摩模式,力度可調,自動定時



- Neck and shoulder, back, waist, buttocks and legs can be used for portability
頸肩、背部、腰部、臀部、腿部均可使用,方便便攜

- Product material 產品材質 /
leather + mesh 皮革+網面
- Working time 工作時間 / 10 minutes / time
- Weight 重量 / 1150g

Multi Functional Shoulder Neck Massage Instrument

多功能肩頸熱敷按摩儀



- Positive and negative human like kneading and massage, with 3D massage techniques in depth
正反仿真人揉捏按摩,3D按摩手法層層深入



- Three step force adjustment, constant temperature hot compress, experience relaxation from shallow to deep
三檔力度調節,恆溫熱敷,體驗由淺到深的放鬆

- Product material 產品材質 / ABS+PC
Working time 工作時間 / 15 minutes / time

- Size 尺寸 / 390*390*150mm
- Weight 重量 / 1300g

Electric head massager

電動頭部按摩器



- Four massage modes, matching and switching, adjustable strength, two-way surround and all-round kneading
四種按摩模式,搭配切換,力度可調,雙向環繞全方位揉捏

- Soft silicone gel, baby like touch, comfortable skin touching experience
柔軟矽膠,嬰兒般觸感,舒適親膚體驗



- Product material 產品材質 /
ABS+lithium battery+motor
ABS+鋰電池+電機

- Color 顏色 / white, pink 白色, 粉色
- Working time 工作時間 / 10 minutes
- Size 尺寸 / 140*110*110mm
- Weight 重量 / 366g

Smart Massage Hot Compress Pillow

智能按摩熱敷安睡枕



- massage and knead with humanoid technique to relieve pain of cervical vertebra and shoulder
仿真人手法按摩推拿揉捏, 釋放頸椎肩酸痛
- Massage pillow that can sleep, the sleeping area fits the neck curve, and infrared warm feeling hot compress
能睡覺的按摩枕, 睡覺區貼合頸部曲線, 紅外溫感熱敷

- Product material 產品材質 /
memory cotton + mesh 記憶棉+網布
- Working time 工作時間 / 15/20/25/30mins
- Size 尺寸 / 440*220*180mm
- Weight 重量 / 980g

Intelligent Moxibustion Massager

智能艾灸按摩器



- Smokeless silent moxibustion, with constant temperature to control the overflow of moxa molecules, directly penetrates into the skin
無煙無聲艾灸, 恆溫控制艾分子溢, 直接滲透皮膚, 睡覺也可以做
- Two mode options: moxibustion function (three levels of temperature can be adjusted), massage function (four massage methods, 16 levels of force can be adjusted)
兩種功能模式選擇: 艾灸功能 (三檔溫度可調節), 按摩功能 (四種按摩方式, 16種檔力度可調節)

- Product material 產品材質 /
ABS+ceramic heater ABS+陶瓷加熱片
- Working time 工作時間 / 15 minutes / time
- Size 尺寸 / 58*43*20mm
- Weight 重量 / 46g

Hot Compress Massage Warm Uterus Belt

熱敷按摩暖宮腰帶



- 3-gear temperature regulation, 3-gear vibration massage, wormwood medicine package, hot compress+medicine package can effectively relieve dysmenorrhea
3擋調溫, 3擋震動按摩, 贈送艾草藥包, 熱敷+藥包有效緩解痛經
- Two mode options: moxibustion function (three levels of temperature can be adjusted), massage function (four massage methods, 16 levels of force can be adjusted)
面料輕薄小巧, 隨身攜帶, 方便收納, 整條可水洗, 適合多部位熱敷: 暖宮/護腰/暖腎/暖胃

- Product material 產品材質 / lycra fabric 萊卡面料
- Temperature 發熱溫度 / 35-55°C
- Colors 顏色 / pink / grey 粉色/灰色
- Size 尺寸 / 1020*120mm
- Weight 重量 / 85g

Digital Display High Frequency Muscle Massage Gun

數顯高頻肌肉按摩槍



- One button start, full touch screen operation, multi gear adjustment and lasting endurance
一鍵啟動, 全觸屏操作, 多檔調節, 持久續航
- Deep massage, strong power, reduce muscle stiffness, and quickly restore vitality
深層按摩, 動力強勁, 減輕肌肉僵硬, 快速回復活力

- Product material 產品材質 / ABS+PC
- Working time 工作時間 / 15 minutes / time
- Speed 轉速 / 3200rpm 轉/分鐘
- Size 尺寸 / 250*185*65mm
- Weight 重量 / 969g

Small Fascia Gun With Hot Compress For Muscle Relaxation

小型帶熱敷肌肉放鬆筋膜槍



MJ



高頻按摩



恆溫熱敷



多檔可調

- 32 range intensity adjustment, 4 range hot compress temperature adjustment, 4 types of massage heads can be replaced to deeply relax your muscles

32檔強度調節,4檔熱敷溫度調節,4款按摩頭可更換,深層放鬆您的肌肉

- The endurance can reach 6 hours in low gear mode
低檔模式下續航時間可達6小時

- Product material 產品材質 / ABS

Speed 轉速 / 1200-3200rpm 轉/分

Size 尺寸 / 143*92mm

Weight 重量 / 350g

Mini Relax Electric Fascia Gun

迷你放鬆電動筋膜槍



MAT



高頻按摩



多檔可調



無線便攜

- Accelerate deep relaxation, promote blood circulation, relieve muscle soreness and stiffness; Compact and portable, multiple massage heads can be replaced

加速深層放鬆,促進血液迴圈,緩解肌肉酸痛和僵硬;小巧便攜,多款按摩頭更換使用

- Large capacity, durable endurance, stable output, 12 gear adjustment intensity

大容量持久續航,穩定輸出,12檔調節強度

- Product material 產品材質 / ABS

Power 功率 / 24W

Working time 工作時間 / 10 minutes

Size 尺寸 / 170*150*50mm

Weight 重量 / 440g

Infra-red Hot Compress Knee Massager

紅外線熱敷膝蓋按摩器

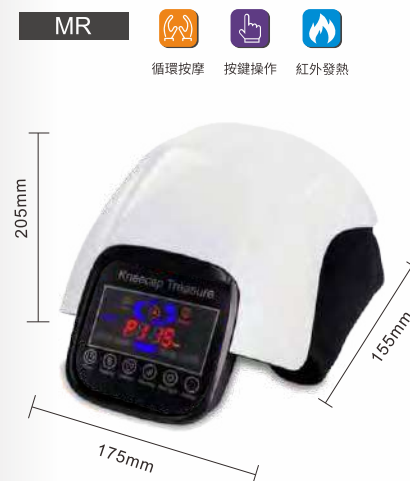

MR



循環按摩



按鍵操作



紅外發熱

- 32 range intensity adjustment, 4 range hot compress temperature adjustment, 4 types of massage heads can be replaced to deeply relax your muscles

立體環線式氣囊環繞膝部,循環充放氣按摩,多檔加熱模式祛除關節濕氣

- The endurance can reach 6 hours in low gear mode
3檔振動按摩釋壓,內置紅光發熱直達膝蓋

- Product material 產品材質 / ABS

Temperature 發熱溫度 / 45/50/55°C

Working time 工作時間 / 15/20/25/30mins

Size 尺寸 / 205*155*175mm

Weight 重量 / 550g

EMS Intelligent Foot Massager

EMS智能足底按摩器

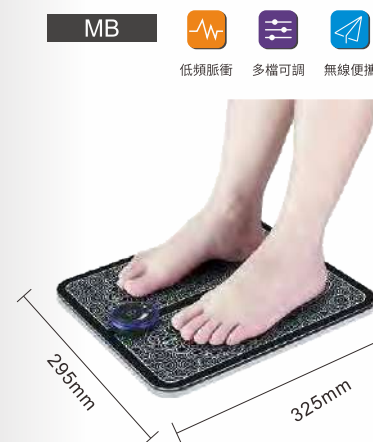

MB



低頻脈衝



多檔可調



無線便攜

- Use electric muscle stimulation (EMS), use electric pulse to induce muscle contraction, strengthen muscle and relieve fatigue

採用電肌肉刺激(EMS),利用電脈衝誘發肌肉收縮,強化肌肉緩解疲勞

- 6 massage modes, 9 levels of gradual strength
6種按摩模式,9級漸變力度

- Product material 產品材質 / PU leather + silver paste + EVA foam cotton board
PU皮革+銀漿+EVA泡沫棉板

Pulse width 脈衝寬度 / 50±10μs

Size 尺寸 / 325*295*5.5mm

Weight 重量 / 168g

Graphene Series

石墨烯系列



Graphene Hot Compress Massage Eye Protector

石墨烯熱敷按摩護眼儀

JDH



按摩舒緩



10秒升溫



石墨烯



- Graphene+infrared thermal energy massage, arc 3D structure, reduce eye pressure
石墨烯+紅外熱能按摩，圓弧3D結構，減少眼球壓迫
- Ten second heating, three gear heating, seven massage modes, 15 minute intelligent massage
10秒升溫，三檔加熱，七個按摩模式，15分鐘智能按摩

- Product material 產品材質 /
PU+sponge+elastic band+elastic cloth+hardware
PU+海棉+鬆緊帶+彈力布+小五金
- Temperature 溫度 / 48°C/42°C/38°C
- Size 尺寸 / 235*90mm
- Weight 重量 / 59.6g

Graphene Heating Neck Protector

石墨烯發熱護頸

JDG



3檔發熱



磁石理療



石墨烯



- Graphene far-infrared hot compress, three seconds of rapid heating, heating uniform
石墨烯遠紅外熱敷，三秒快速發熱，發熱均勻
- Skin-friendly and breathable Lycra fabric with built-in magnet can relieve cervical discomfort
親膚透氣萊卡面料，內置磁石，舒緩頸椎不適

- Product material 產品材質 /
lycra fabric 萊卡面料
- Temperature 發熱溫度 / 45°C、55°C、65°C
- Size 尺寸 / 470*85*35mm
- Weight 重量 / 160g

Warm Palace Belt With Hot Compress

熱敷調理暖宮腰帶



- Rapid heating of graphene, large area hot compress, 3-gear temperature control, warming the uterus and expelling cold
石墨烯快速發熱,大面積熱敷,3檔控溫,暖宮驅寒

- Three level simulated human massage, stimulate multiple acupoints, and relieve waist and abdomen muscles
三檔仿真人按摩,刺激多點穴位,舒緩腰腹部肌肉

- Product material 產品材質 /
ABS + flannel ABS+絨布

Temperature 發熱溫度 / 40°C、50°C、60°C

Size 尺寸 / 190*84*34mm

Weight 重量 / 161g

Graphene heated massage belt

石墨烯加熱按摩暖宮帶



- Rapid heating of graphene, three step constant temperature hot compress, warming the uterus and expelling cold
石墨烯快速發熱,三檔恒溫熱敷,暖宮驅寒

- Smart timing, simulated human kneading, relieve discomfort
智能定時,仿真人揉捏,舒緩不適

- Product material 產品材質 /
PU+萊卡+海棉 PU+ lycra + sponge

Temperature 發熱溫度 / 45°C、55°C、65°C

Size 尺寸 / 315*127*15mm

Weight 重量 / 161g

Graphene Hot Compress Massage Eye Protector

石墨烯電加熱護腰



- Graphene heats up fast and eases lumbar discomfort
石墨烯發熱,升溫速度快,緩和腰部不適

- Light and safe, overheat protection, automatic power off when the temperature is too high, eliminate hidden dangers
輕便安全,過熱保護,溫度過高自動斷電,杜絕隱患

- Product material 產品材質 /
lycra, OK cloth 萊卡, OK

Temperature 溫度 / 40°C、50°C、60°C

Size 尺寸 / 1100*180mm

Weight 重量 / 190g

Graphene Hot Compress Massage Belt

石墨烯熱敷按摩腰帶

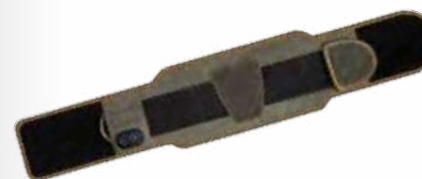

- Graphene far-infrared hot compress, uniform heating, temperature control at 3 levels
石墨烯遠紅外熱敷,發熱均勻,3檔控溫

- Five high frequency vibration adjustable, simulation of human beating, relax lumbar muscles
五檔高頻震動可調,仿真人捶打,放鬆腰椎肌肉

- Product material 產品材質 / PU

Temperature 發熱溫度 / 45°C、55°C、65°C

Size 尺寸 / 1180*210mm

Weight 重量 / 550g

Warm Palace Belt With Hot Compress

熱敷調理暖宮腰帶



- Integrated far-infrared heating technology, shoulder and knee dual use, moxibustion hot compress, effective pain relief

遠紅外發熱技術一體式發熱, 肩膝兩用, 艾灸熱敷, 高效舒緩疼痛

- Intelligent temperature control, three gear adjustment, and point massage with simulated human massage

智能控溫, 三檔調節, 仿真人按摩手法穴位定點按摩

- Product material 產品材質 / PU+sponge+elastic band+elastic cloth
PU+海棉+鬆緊帶+彈力布

Temperature 發熱溫度 / 45°C、55°C、65°C

Size 尺寸 / 660*285mm

Weight 重量 / 210.6g*2

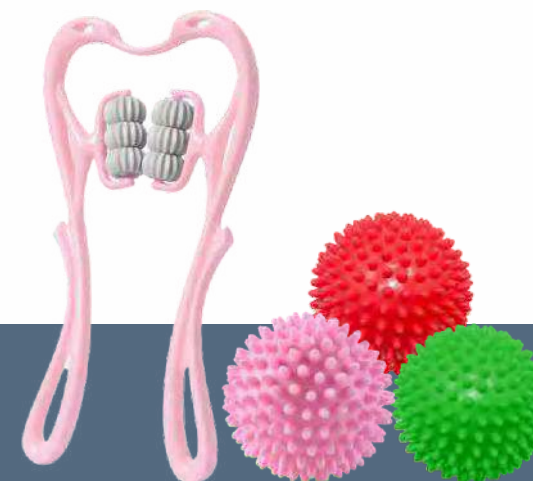

Physical Massager

物理按摩器

Hedgehog Massage Ball

刺蝟全身按摩球

MD



滾動按摩 穴位刺激 小巧便攜

- Small and portable spike ball, no time and place restrictions, massage anytime and anywhere

小巧便攜小刺球, 不受時間地點限制, 隨時隨地按摩

- Relieve muscle tension, stimulate local acupoints, and reduce muscle tension

緩解肌肉緊張, 刺激局部穴位, 並減少肌肉緊張

- Product material 產品材質 / PVC

Color 顏色 / Red, blue, pink, green, purple
紅, 藍, 粉, 綠, 紫

Size 尺寸 / Φ 75mm Φ 90mm

Weight 重量 / 59g 79g

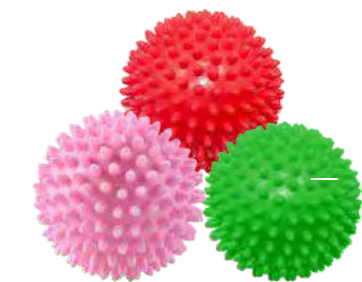

Silicone Hedgehog Massage Ball

矽膠刺蝟按摩球

MX



滾動按摩 穴位刺激 小巧便攜

- Hollow air pressure without inflation, full of elasticity

空心氣壓無需充氣, 彈力十足

- Spherical floating point soft thorn design, massaging muscles to relieve muscle soreness

球體浮點軟刺設計, 按摩肌肉緩解肌肉酸痛

- Product material 產品材質 / Silicone 矽膠

Size 尺寸 / Φ 75mm Φ 90mm

Weight 重量 / 59g 79g



Roller Cervical Vertebra Massager

滾輪頸椎按摩器

MBM



滾動按摩 輕巧便攜

- The massage wheel is soft and elastic, stimulating the acupoints, and the massage is more comfortable

按摩輪柔軟有彈性, 刺激穴位, 按摩更舒適

- The massage wheel can be rotated, and the movement direction of the wheel can be adjusted as required

按摩輪可旋轉角度, 根據需求, 隨意調整滾輪運動方向

- Product material 產品材質 / TPR+PP

Size 尺寸 / 150-90*40mm

Weight 重量 / 260g



Yuhua Stone Foot Massage Blanket

雨花石腳底按摩毯

MAO



穴位按摩 材質天然

- Natural rain flower stone material is used, which is healthy and environmentally friendly

採用天然雨花石材料, 健康環保

- Multi point acupoints for plantar stimulation

足底刺激多點穴位

- Product material 產品材質 / soft plastic+rain flower stone 軟塑膠+雨花石

Size 尺寸 / 400*1500*20mm

Weight 重量 / 8400g



Aluminum Alloy Manual Wheelchair Portable

鋁合金手動輪椅

WAW



摺疊方便



結構穩固

- The massage wheel can be rotated, and the movement direction of the wheel can be adjusted as required
加寬座位, 輕便小巧前後共4剎車, 折疊設計更方便

- Product material 產品材質 / aluminum alloy + oxford cloth 鋁合金+牛津布

Weight 重量 / 1150g



Folding Trolley Aid With Storage Aluminum Alloy

帶收納鋁合金折疊助行車

WBU



摺疊方便



結構穩固



購物袋

- Six gear height adjustable, foldable storage, convenient for travel
六檔高度可調, 可折疊收納, 方便出行

- Product material 產品材質 / aluminum alloy + oxford cloth 鋁合金+牛津布

Weight 重量 / 7600g



Wheelchair & Walking Aids

輪椅 & 助行器

Foldable Aluminum Alloy Walker

可摺疊鋁合金助行器



摺疊方便 結構穩固 高度可調

- Aluminum alloy material is safe and stable, with adjustable height and foldable storage
鋁合金材質安全穩固,高度可調節,可折疊收納

- Product material 產品材質 / aluminum alloy 鋁合金

Weight 重量 / 2500g



Aluminum Alloy Walker With Curved Handrails

帶彎曲扶手鋁合金助步器



摺疊方便 結構穩固 高度可調

- Aluminum alloy material, safe, stable, foldable, height adjustable, and S-bend design
鋁合金材質,安全穩固可折疊,高度可調節,輔助起身S彎設計

- Product material 產品材質 / aluminum alloy 鋁合金

Weight 重量 / 2500g



摺疊方便 結構穩固 可做座椅

- Aluminum alloy material, adjustable height, with oxford cloth cushion, foldable storage, convenient for travel
鋁合金材質,高度可調,附帶牛津布坐墊,可折疊收納,方便出行

- Product material 產品材質 / aluminum alloy + oxford cloth 鋁合金+牛津布

Weight 重量 / 2500g

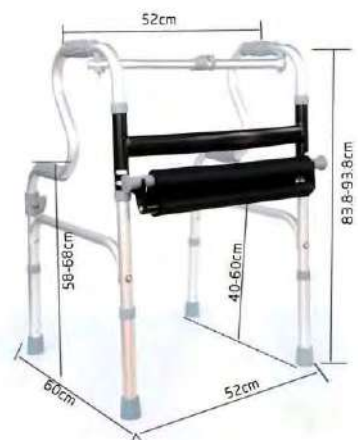

摺疊方便 結構穩固 滾輪助行

- Aluminum alloy material, safe and stable, adjustable height, foldable storage, rear foot roller design, more convenient for walking
鋁合金材質,安全穩固,高度可調,可折疊收納,後腳滾輪設計,助行更方便

- Product material 產品材質 / aluminum alloy 鋁合金

Weight 重量 / 2500g





Crutches

拐杖



Folding Crutch Chair With Light

WBT 可折疊帶燈拐杖椅

- Aluminum alloy material, stable tripod base, 5-gear height adjustable, handle LED light design, convenient for night travel

鋁合金材質, 穩固三腳底座, 5檔高度可調節, 把手LED燈設計, 夜晚出行也方便

- Product material 產品材質 / aluminum alloy 鋁合金

Weight 重量 / 1100g



Folding Crutch Chair With Light

WBC 可折疊帶燈拐杖椅

- Stable tripod base, 5-gear height adjustable, with FM radio function; Handle LED light design, fall audible and visual alarm function

穩固三腳底座, 5檔高度可調節, 帶FM收音機功能; 把手LED燈設計, 跌倒聲光警報功能

- Product material 產品材質 / aluminum alloy 鋁合金

Weight 重量 / 1000g



Four Legged Cane Stool

WAB 四腳手杖凳

- Stable four corner design, enlarged round stool surface

- Product material 產品材質 / aluminum alloy 鋁合金

Weight 重量 / 985g



Anti-slip Folding Crutch With Alarm

WAG 帶警報防滑折疊拐杖

- Foldable aluminum alloy, adjustable height, with alarm function; Handle LED lamp design, with light angle adjusted by 45°

鋁合金材質可摺疊，高度可調節，帶警報器功能；把手LED燈設計，45°調整光照角度

- Product material 產品材質 / aluminum alloy 鋁合金

Weight 重量 / 391g



Folding Walking Stick With Light

WAF 可折疊帶燈拐杖

- Aluminum alloy material, stable tripod base, 5-gear height adjustable, handle LED light design, convenient for night travel

鋁合金材質，四腳底座，5檔高度可調節，把手LED燈設計，夜晚出行也方便

- Product material 產品材質 / aluminum alloy 鋁合金

Weight 重量 / 391g



Folding Crutch With Light

WAR 帶燈折疊拐杖

- Aluminum alloy tube body, 5-gear height adjustable, foldable design; Flashlight lighting function, convenient for night travel

鋁合金管身，5檔高度可調節，可折疊設計；手電筒照明功能，方便夜間出行

- Product material 產品材質 / aluminum alloy 鋁合金

Weight 重量 / 416g



Intelligent Alarm Cane With Umbrella

WAZ 智能報警傘杖

- Can be used as crutches, umbrellas, fall alarms, with lighting, MP3, radio, red light warning functions

可做拐杖，可做雨傘，跌倒警報，附帶照明、mp3、收音機、紅光警示功能

- Product material 產品材質 / aluminum alloy + bumping cloth + fiberglass 鋁合金+碰擊布+玻纖

Weight 重量 / 620g



Foldable Intelligent Walking Stick

WAY 可折疊智能手杖

- Foldable aluminum alloy, adjustable height, fall alarm; With lighting, MP3, radio and red light warning functions

鋁合金材質可摺疊，高度可調節，跌倒警報器；附帶照明、mp3、收音機、紅光警示功能

- Product material 產品材質 / aluminum alloy 鋁合金

Weight 重量 / 385g



Height Adjustable Non-slip Walking Stick

WBA/WBB 可調節防滑手杖

- Stable four corner design, enlarged round stool surface

穩固四角設計，有10檔可調高度

- Product material 產品材質 / aluminum alloy + ABS 鋁合金 + ABS

Weight 重量 / 985g



Aluminum Alloy Anti-skid Walking Stick

WAX 鋁合金防滑手杖

- Aluminum alloy material, adjustable 10 gear height, silicone protective bottom cushion
鋁合金材質, 10檔高度可調節, 矽膠防護底墊

- Product material 產品材質 / aluminum alloy+silicone 鋁合金+矽膠

Weight 重量 / 300g



Foldable Printed Crutch

WBJ 可折疊印花拐杖

- Aluminum alloy material, stable quadruped base, 5-gear height adjustable
鋁合金材質, 穩固四腳底座, 5檔高度可調節

- Product material 產品材質 / aluminum alloy 鋁合金

Weight 重量 / 667g



Folding Aluminum Alloy Armpit Crutch

WAU 折疊鋁合金腋拐

- Thickened material, high load bearing, soft TPR armpit support, height adjustment at 13th gear
加厚材質高度承重, 軟性TPR腋托, 高度13檔調節

- Product material 產品材質 / aluminum alloy+TPR 鋁合金+TPR

Weight 重量 / 1800g



Solid Wood Non Slip Walking Stick

WAH 實木防滑手杖

- Solid wood is firm, smooth and round, with Oxford anti slip rubber cover at the bottom
實木結實穩固, 光滑圓潤, 底部牛津防滑膠套

- Product material 產品材質 / wenge wood 雞翅木

Weight 重量 / 479g



Aluminum Alloy Crutch

WBD 鋁合金拐杖

- The staff body is made of aluminum alloy, with adjustable telescopic design of 10 gears, and the arm ring is close to the arm, safe and comfortable

杖身鋁合金材質, 10檔可調節伸縮設計, 臂圈緊貼手臂安全舒適

- Product material 產品材質 / aluminum alloy+ABS 鋁合金+ABS

Weight 重量 / 440g



Folding Climbing Stick

WAP 折疊登山杖

- Alloy material with high strength and toughness, comfortable EVA handle, PA material external locking, screw in installation, convenient disassembly
強度韌性高的合金材料, 舒適EVA手柄, PA材質外鎖鎖定, 螺旋擰入式安裝, 拆卸方便

- Product material 產品材質 / aluminum alloy + EVA material 鋁合金+EVA材質

Weight 重量 / M:250g L:270g



Handrail & Potty Chair

扶手&坐便椅

Stainless Steel Safety Handle

WAK 不銹鋼安全拉手

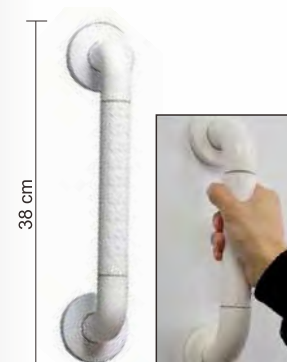

- Large grain convex anti-skid, built-in thickened stainless steel inner tube, firm anti-skid, super load-bearing
大顆粒凸防滑, 內置加厚不銹鋼內管, 牢固防滑, 超強承重

- Product material 產品材質 /
tube nylon +304 stainless steel
外管尼龍+304不銹鋼內管

Weight 重量 / 705g

Basin Handrail

WAS 臺盆扶手



- Large grain convex anti-skid, built-in thickened stainless steel inner tube, firm anti-skid, super load-bearing
大顆粒凸防滑, 內置加厚不銹鋼內管, 牢固防滑, 超強承重

- Product material 產品材質 /
tube nylon +304 stainless steel
外管尼龍+304不銹鋼內管

Weight 重量 / 2950g

Toilet Armrest

WBV 衛生間馬桶扶手

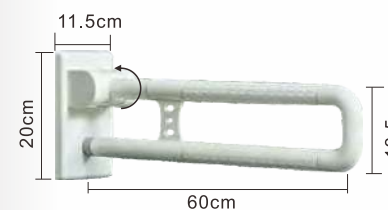

- Large grain convex anti-skid, built-in thickened stainless steel inner tube, firm anti-skid, super load-bearing
大顆粒凸防滑, 內置加厚不銹鋼內管, 牢固防滑, 超強承重

- Product material 產品材質 /
aluminum alloy + EVA material
鋁合金+EVA材質

Weight 重量 / 2950g



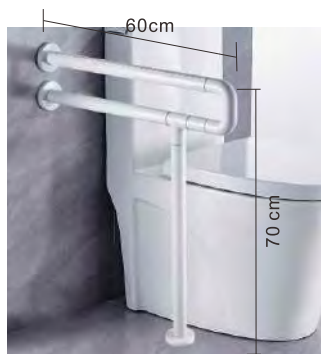

U-shaped Toilet Handrail

WAT U型坐便器扶手

- Large grain convex anti-skid, built-in thickened stainless steel inner tube, firm anti-skid, super load-bearing

大顆粒凸防滑,內置加厚不鏽鋼內管,牢固防滑,超強承重

- Product material 產品材質 / tube nylon +304 stainless steel
外管尼龍+304不鏽鋼內管

Weight 重量 / 2200g



Folding Toilet Handrail

WBW 可摺疊坐便器扶手

- Large grain convex anti-skid, built-in thickened stainless steel inner tube, firm anti-skid, super load-bearing

大顆粒凸防滑,內置加厚不鏽鋼內管,牢固防滑,超強承重

- Product material 產品材質 / tube nylon +304 stainless steel
外管尼龍+304不鏽鋼內管

Weight 重量 / 3450g



Folding Toilet Chair

WCA 可折疊坐便椅

- The design of portable toilet is convenient for different people to use and care; Folding structure, convenient storage, no floor space

可抽可提便桶設計,方便不同人士使用及護理;折疊結構,收納方便不占地

- Product material 產品材質 / steel pipe+blow molding 鋼管+吹塑

Weight 重量 / 7400g



Limb Fixation

肢體固定



Wheelchair Strap

NAE 輪椅固定帶

- It adopts snap connection, adjustable, fixed with double shoulder velcro, adjustable and loose, 採用卡扣式連接, 可調節, 雙肩魔术貼固定, 可調節鬆

- Product material 產品材質 / velvet perforated cloth + OK cloth 天鵝絨孔布+OK布

Weight 重量 / 176g



Limb Fixing Gloves

NAP 肢體固定手套

- The zipper opening design can be used as a seal for blood oxygen detection 拉鏈開口設計, 可以當封口使用, 可用於血氧檢測

- Product material 產品材質 / mesh / cushion coated rubber sheet 網布/軟墊裹覆膠板

Weight 重量 / 325g

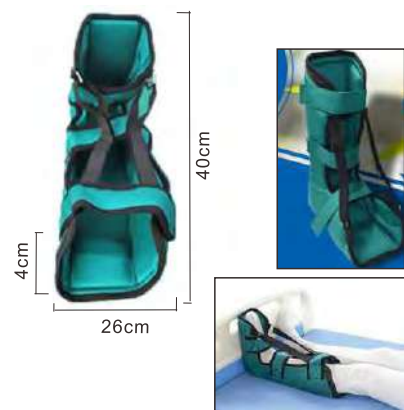

Ankle Rehabilitation Fixed Protective Cover

NAQ 踝關節復康固定保護套

- The built-in fixing plate can effectively support the lower leg, which is stable and comfortable to use; Built in decompression cotton, strong wrapping for ankle joint 內置固定板, 有效支撐小腿, 使用穩固、舒適; 內置減壓棉, 對踝關節包裹性強

- Product material 產品材質 / high elastic sponge, twill cotton 高彈力海綿、斜紋棉布

Weight 重量 / 340g



Wheelchair Strap

NAR 輪椅固定帶

- Safety buckle, better protection against strap slipping; Padded abdomen for comfort and relaxation 安全插扣, 防止織帶滑落更好保護; 腹部加置軟墊, 舒適輕鬆

- Product material 產品材質 / high elastic sponge + OK cloth 高彈力海綿+OK布

Weight 重量 / 325g



Adjustable Restraining Belt

NBC 可調約束帶安全帶

- Prevent getting up, falling off the bed and rolling over. There is room for turning left and right 防止起身、墜床、側翻, 有活動空間可以左右翻身

- Product material 產品材質 / polyester cotton + nylon 滌棉+尼龍

Weight 重量 / 485g



Leg Fixed Restraint Strap

NBD 腿部約固定帶

- polyester cotton material is durable, easy to wear and operate 滌棉材質堅固耐用, 穿戴方便簡單, 操作快捷

- Product material 產品材質 / polyester cotton 滌棉

Weight 重量 / 435g



Posture Cushion

體位墊



Cylindrical Scaffold Sponge Pad

NAO 圓柱腳手圈海綿支撐墊

- High density sponge material, soft and comfortable, cylindrical design effectively supports the affected part
高密度海綿材質, 柔軟舒適, 圓柱設計有效支撐患部



- Product material 產品材質 /
high-density sponge, cotton cloth
高密度海綿, 棉布

Weight 重量 / 46g



Concave Multipurpose Ankle Pad

NAN 凹形多用踝骨墊

- U-shaped design can effectively support the affected part and lift the neck, wrist or ankle
U型設計有效支撐患部, 抬高頸部、腕部或者腳踝處

- Product material 產品材質 /
high-density sponge, cotton cloth
高密度海綿, 棉布

Weight 重量 / 42g

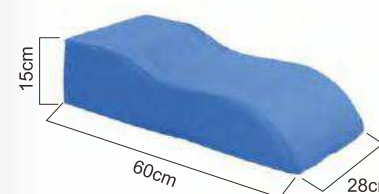

Leg Raising Roll Over Pad

NAM 腿部抬高翻身墊

- Raise the lower limbs by 15cm and keep their physiological bending
抬高下肢15cm並保持下肢生理彎曲

- Product material 產品材質 /
polyester cotton 滌棉

Weight 重量 / 500g



Leg Raising Pad

NAL 腿部抬高下肢墊

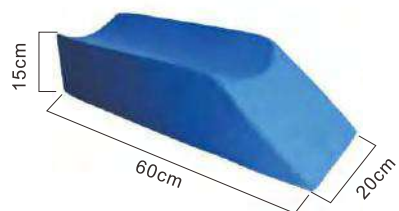

- High density sponge material, soft and comfortable, supporting lower limbs

高密度海綿材質, 柔軟舒適, 支撐下肢

- Product material 產品材質 / high-density sponge, cotton cloth

高密度海綿, 棉布

Weight 重量 / 485g

Triangular Upper Limb Side Pad

NAJ 三角康復上肢側身墊

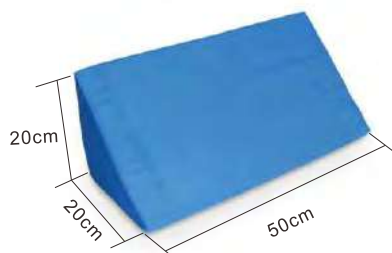

- Triangular design, providing support in lateral and prone positions

三角型設計, 提供側臥位及俯臥位時的支撐

- Product material 產品材質 / high-density sponge, cotton cloth

高密度海綿, 棉布

Weight 重量 / 480g

Turn Over Auxiliary Pad

NAX 臥床翻身輔助器

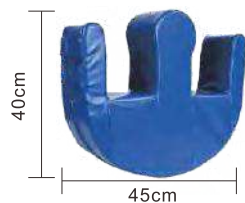

- High quality sponge lining, waterproof PU fabric, comfortable, soft, durable

優質海綿內裡, 防水PU面料, 舒適柔軟, 結實耐用

- Product material 產品材質 / PU leather + rebound cotton

PU皮+回彈棉

Weight 重量 / 550g

Anti Bedsore Displacement Leak Proof Pad

NAF 防褥瘡移位隔尿墊



- 8 tote bags, convenient for multi direction movement, roll over pad+urine pad in one

8條手提袋, 方便多方位移動, 翻身墊+尿墊合一

- Product material 產品材質 / waterproof oxford cloth, mesh cloth, absorbent sponge, webbing

防水牛津布、網眼布、吸水海綿、織帶

Weight 重量 / 687g

Turn Over Nursing Belt

NAC 翻身護理帶

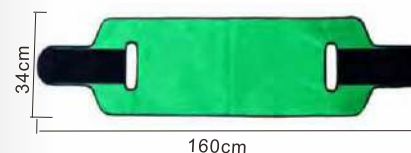

- It is more convenient to operate. It can be operated after turning left and right. It is a good helper for nursing

操作更方便, 左右翻身一拉就可操作, 護理好幫手



- Product material 產品材質 / oxford cloth + shredded milk

牛津布+牛奶絲

Weight 重量 / 300g



Incontinence Care Products

失禁護理

Medical Silicone Urine Connector

NAA 醫用矽膠接尿器



- The liquid silicone adhesive is soft and durable, and the anti backflow soft edge can make the urine receiver fit the body better, with better leak proof effect

液體矽膠具柔軟更耐用, 防回流軟邊能讓接尿器和身體更加貼合, 防漏效果更好

- Product material 產品材質 / medical silicone glue 醫用矽膠

Weight 重量 / 205g

Household Urinals

NAS 家用款小便壺



- The portable handle is convenient to carry; Scale is easy to measure; Covered, anti rollover liquid

具有手提柄, 方便攜帶; 有刻度, 便於測量; 有蓋, 防打翻液體



- Product material 產品材質 / plastic 塑膠

Weight 重量 / 190g

Intelligent Urination Nursing Instrument

NBI 智能大小便護理儀



臥便器 專用床墊



- Automatic induction, collection, flushing and drying functions, special odor elimination function and noise elimination function

自動感應、收集、沖洗、烘乾功能，特設消除臭味功能，消除噪音功能

- Product material 產品材質 / plastic + cotton cloth + brown pad + sponge 塑膠+棉布+棕墊+海綿

Weight 重量 / 35000g

Washable Non Slip Urinal Mat

NAZ 可清洗防滑隔尿墊

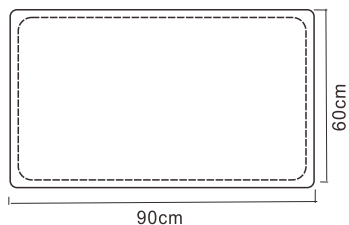

- Four layer urine barrier, effective leak proof, washable, non fading, non slip and non shifting

四層隔尿，有效防漏，可水洗，不掉色，使用防滑不移位

- Product material 產品材質 / polyester fiber, breathable mesh, absorbent cotton, TPU 聚酯纖維，透氣網布，吸水棉，TPU防水膜

Weight 重量 / 190g

Disposable Sanitary Care Pad

NBJ 一次性衛生護理墊



- Breathable PE bottom film, double breathability, no fluorescent agent, safe and environmentally friendly 透氣PE底膜，加倍透氣，不含螢光劑，安全環保

- Product material 產品材質 / non woven fabric, absorbent paper, wood pulp cotton, SAP polymer, PE film 無紡布、吸水紙、木漿棉、SAP高分子、PE膜

Spec 產品規格 / 10 Piece pack 10片裝

Adult Diapers

NBK 成人紙尿褲



- Dual three-dimensional protection, designed according to ergonomics, effectively prevents side leakage, 1800ml large absorption

雙重立體防護，根據人體工學設計，有效防側漏，1800ml大吸量

- Product material 產品材質 / non woven fabric, high polymer absorbent resin, absorbent paper 無紡布、高分子吸水樹脂、吸水紙

Spec 產品規格 / L, 10 pcs

Adult Diapers

NBL 成人紙尿褲



- Instantaneous suction and water locking without reverse osmosis, double three-dimensional protection design, effectively preventing side leakage 瞬吸鎖水不反滲，雙重立體防護設計，有效防側漏

- Product material 產品材質 / non woven fabric, high polymer absorbent resin, absorbent paper 無紡布、高分子吸水樹脂、吸水紙

Spec 產品規格 / M/L, 10 pcs

Hand Wound Shower Waterproof Cover

NBA 手部創傷沐浴防水套

- It can protect the injured part and prevent it from getting worse when encountering water
可保護患處, 防止遇水惡化

● Product material 產品材質 /
PVC silica gel PVC 矽膠

Weight 重量 / 108g

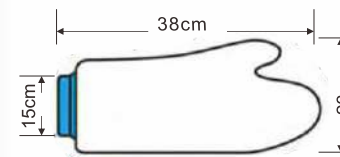

Arm Wound Shower Waterproof Cover

NBN 手臂創傷沐浴防水套

- It can protect the injured part and prevent it from getting worse when encountering water
可保護患處, 防止遇水惡化

● Product material 產品材質 /
PVC silica gel PVC 矽膠

Weight 重量 / 130g / 125g

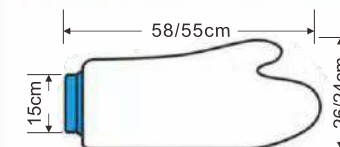

Foot Trauma Bath Waterproof Cover

NBO 腳部創傷沐浴防水套

- It can protect the injured part and prevent it from getting worse when encountering water
可保護患處, 防止遇水惡化

● Product material 產品材質 /
PVC silica gel PVC 矽膠

Weight 重量 / 108g/140g

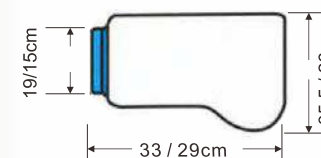

Other Care Products

其他護理





Leg Wound Bath Waterproof Cover

NAP 腿部創傷沐浴防水套

- It can protect the injured part and prevent it from getting worse when encountering water

可保護患處, 防止遇水惡化

- Product material 產品材質 /
PVC silica gel PVC 矽膠

Weight 重量 / 198g / 178g